

A Practical Guide for Resource Monitoring and Control (RMC)

Configure RMC using the Web-based System
Manager

Comprehensive examples of the RMC
command line interface

Practical examples on how to
monitor your applications

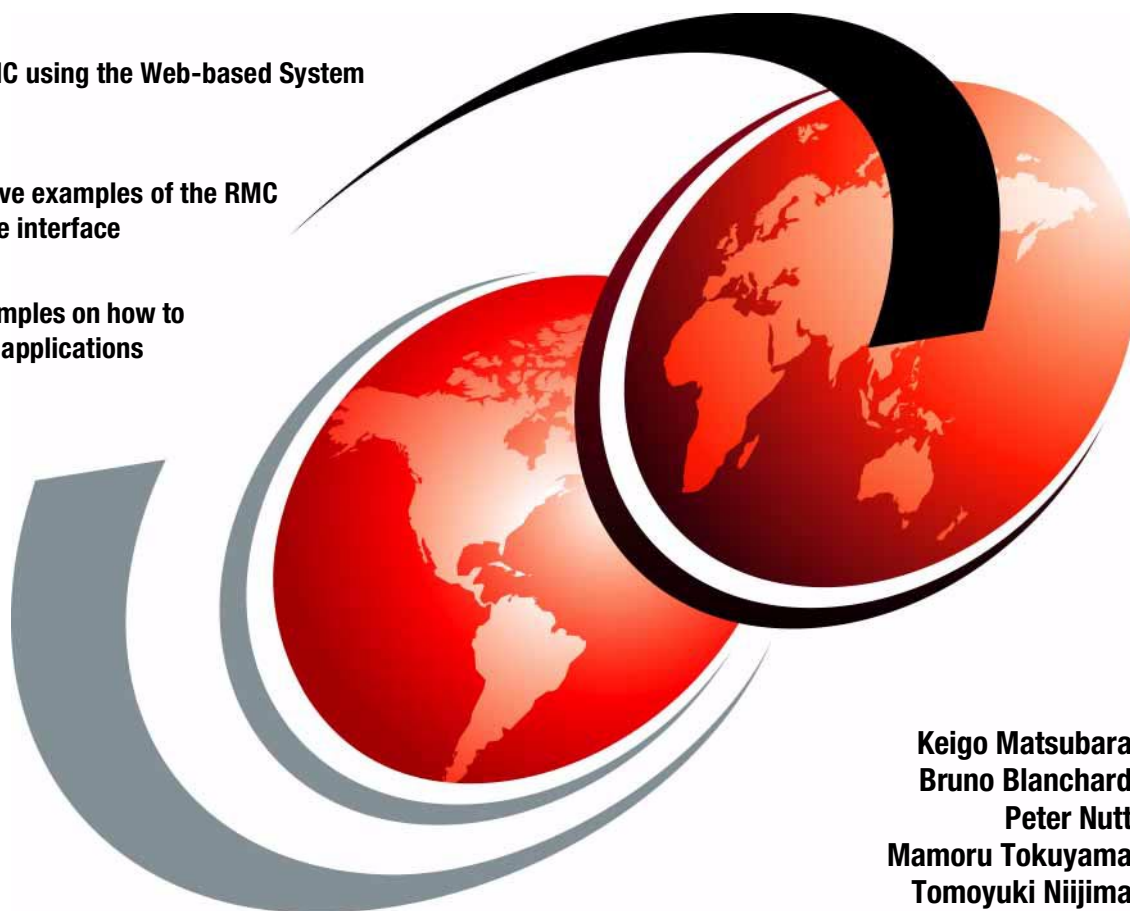

Keigo Matsubara
Bruno Blanchard
Peter Nutt
Mamoru Tokuyama
Tomoyuki Niijima



International Technical Support Organization

**A Practical Guide for Resource Monitoring and
Control (RMC)**

August 2002

Note: Before using this information and the product it supports, read the information in “Notices” on page xi.

First Edition (August 2002)

This edition applies to AIX 5L Version 5.1 (product number 5765-E61).

Note: This book is based on a pre-GA version of a product and may not apply when the product becomes generally available. We recommend that you consult the product documentation or follow-on versions of this redbook for more current information.

© Copyright International Business Machines Corporation 2002. All rights reserved.

Note to U.S. Government Users Restricted Rights -- Use, duplication or disclosure restricted by GSA ADP Schedule Contract with IBM Corp.

Contents

Figures	vii
Tables	ix
Notices	xi
Trademarks	xii
Preface	xiii
The team that wrote this redbook	xiii
Become a published author	xiv
Comments welcome	xv
Chapter 1. Introduction	1
1.1 What is RMC	2
1.2 The evolution of RMC	4
1.3 Clustered environment	5
1.3.1 Peer domain	6
1.3.2 Management domain	7
1.4 RMC software packaging	8
1.4.1 Filesets and packages	9
1.4.2 Uninstall RMC from your system	12
1.4.3 Reinstall RMC on your system	12
Chapter 2. Architecture and components	15
2.1 A glance at the architecture	16
2.1.1 RMC clients	17
2.2 Resource, resource class, and attribute	19
2.2.1 Resource	20
2.2.2 Resource class	21
2.2.3 Attribute	21
2.3 Resource managers	23
2.3.1 Event Response resource manager (ERRM)	24
2.3.2 Audit Log resource manager	26
2.3.3 Configuration resource manager	27
2.3.4 File system resource manager	28
2.3.5 Host resource manager	28
2.3.6 Sensor resource manager	29
2.4 Expression	30
2.5 Condition, response, and action	30

2.5.1	Condition	30
2.5.2	Action	32
2.5.3	Response	33
2.5.4	Association between a condition with a response.	34
2.6	Directory structure used by RMC	35
Chapter 3. Quick start: using RMC		37
3.1	AIX 5L Version 5.1 Web-based System Manager.	38
3.1.1	Enable remote Web-based System Manager access.	40
3.1.2	Install Web-based System Manager PC client	40
3.1.3	Connect to AIX 5L Version 5.1 system using the PC client	41
3.1.4	Connections to multiple hosts	42
3.2	RMC setup procedure	45
3.2.1	Basic RMC concepts.	45
3.2.2	Step one: the Monitoring plug-in	48
3.2.3	Step two: the Conditions plug-in	48
3.2.4	Monitoring a condition.	49
3.2.5	Viewing events	54
3.3	Customizing your RMC configuration	57
3.3.1	Properties of a condition	57
3.3.2	Monitored resources	58
3.3.3	General Condition Properties	61
3.3.4	Responses to a condition	63
3.4	Creating a new condition or response.	70
3.4.1	Creating a new condition.	71
3.4.2	Creating a new response	80
3.4.3	The /home/remount script	89
3.4.4	Generating the event.	90
Chapter 4. RMC command line interface		93
4.1	Test environment.	94
4.2	Common variables and command flags	95
4.2.1	Environment variables.	95
4.2.2	Command flags and pattern match operators.	99
4.2.3	Persistent property value file.	106
4.3	A peer domain cluster setup	106
4.3.1	Required filesets	107
4.3.2	Preparing your node security	107
4.3.3	Creating the cluster.	107
4.3.4	Bringing the cluster online	108
4.3.5	Adding a node to the cluster	109
4.3.6	Bringing a node online	110
4.3.7	Stopping (offline) a node in the cluster	110

4.3.8	Removing a node from the cluster	111
4.3.9	Stopping (offline) a cluster	111
4.3.10	Removing a cluster	112
4.4	SRC commands	112
4.4.1	lssrc	112
4.4.2	nlsrc	113
4.4.3	Other SRC commands	113
4.5	RSCT commands	114
4.6	RMC commands	114
4.6.1	lsrsrc	115
4.6.2	lsrsrcdef	119
4.6.3	refsrc	121
4.7	Sensor commands	122
4.7.1	lssensor	123
4.7.2	mksensor	125
4.7.3	chsensor	125
4.7.4	rmsensor	125
4.8	ERRM commands	126
4.8.1	Location concepts	127
4.8.2	lscondition	127
4.8.3	lsresponse	132
4.8.4	lscondresp	134
4.8.5	mkcondition	135
4.8.6	mkresponse	137
4.8.7	mkcondresp/startcondresp	139
4.8.8	chcondition	139
4.8.9	chresponse	141
4.8.10	stopcondresp/rmcondresp	141
4.8.11	rmcondition/rmresponse	141
4.9	Audit Log commands	142
4.10	Additional security configuration	143
4.10.1	Authorization	143
4.10.2	Remote node access	147
Chapter 5.	Monitoring applications	151
5.1	How to monitor DB2 Universal Database	152
5.1.1	Components to be monitored	153
5.1.2	Configure a DB2 UDB monitor resource	155
5.2	Advanced monitoring	156
5.2.1	Define your own sensor	156
5.2.2	Advanced monitoring example	160
5.2.3	Creating your own response	166
5.3	How to send events to Tivoli Enterprise Console	170

5.3.1 System environment of TEC	171
5.3.2 Create an action script to report to TEC	172
Appendix A. Filesets level information	175
RSCT and RMC filesets level.	176
Web-based System Manager filesets level	177
Appendix B. Useful information	179
rsct.core.README	180
Description	180
Installation information	180
Advisories	181
World Wide Web access information	183
Perl/Expect installation	184
Abbreviations and acronyms	187
Related publications	189
IBM Redbooks	189
Other resources	189
Referenced Web sites	190
How to get IBM Redbooks	190
IBM Redbooks collections.	191
Index	193

Figures

1-1	Overview of AIX cluster architecture	3
1-2	Peer domain cluster topology	7
1-3	Management domain cluster topology	8
2-1	Detailed relationship between RMC components and clients	16
2-2	Relationship between RMC clients and RMC sub systems	18
2-3	Resource managers, resource classes, resources, and attributes	20
2-4	Condition, expression, and events	32
2-5	Conditions, responses, and actions	35
3-1	AIX 5L Version 5.1 Web-based System Manager	39
3-2	Log On dialog box	41
3-3	The Web-based System Manager window	42
3-4	Adding hosts to the management environment	43
3-5	Selecting a host to manage	43
3-6	Log On window	44
3-7	Tiled windows	45
3-8	Condition properties dialog box	46
3-9	Selecting the Monitoring plug-in	48
3-10	Selecting the Conditions plug-in	49
3-11	Conditions pop-up window	50
3-12	Edit responses dialog box (before selection)	51
3-13	Edit responses dialog box (after selection)	52
3-14	Monitoring started display	53
3-15	Selecting the Events plug-in	55
3-16	Events plug-in	56
3-17	Event properties dialog box	57
3-18	Displaying the properties of a condition	58
3-19	Condition Properties dialog box	59
3-20	Condition Properties: Monitored Resources dialog box	60
3-21	Selecting an additional resource	61
3-22	Condition Properties dialog box: changing the rearm expression	62
3-23	Condition Properties dialog box: changing the monitored property	63
3-24	Condition Properties: Responses to Condition button	64
3-25	Edit Responses to Condition	65
3-26	Response Properties dialog box	66
3-27	Modify Actions dialog box	67
3-28	Modify Action: When in Effect	68
3-29	Modify action: setting the new period	69
3-30	Modify action: new period addition complete	70

3-31	Creating a new condition from the Overview and Tasks plug-in	71
3-32	New Condition dialog box	72
3-33	New condition: file system resource class	73
3-34	New condition: monitored resources, all file systems	74
3-35	New condition: /work04 file system selected	75
3-36	New condition: OpState monitored property	76
3-37	New condition, expressions completed	77
3-38	New condition: severity definition	78
3-39	New condition created	79
3-40	Events panel showing different severity events	80
3-41	New response: drop-down menu	81
3-42	Edit Response: create a response button	82
3-43	New Response dialog box: specifying the name of the response	83
3-44	Add Action dialog box	84
3-45	New response: When in Effect tab	85
3-46	Time in Effect is required	85
3-47	New response: When in Effect page period defined	86
3-48	New Response: Attempt remount created	87
3-49	New Response: Attempt remount selected as a response	88
3-50	New condition starts monitoring	89
3-51	Monitoring: Events window (all events)	92
4-1	RMC test environment	94
4-2	The concept of CT_CONTACT	97
4-3	The concept of CT_MANAGEMENT_SCOPE	98
4-4	Remote management without a cluster configuration	147
5-1	Relationship between sensor, response, and others	160
5-2	Test environment with a TEC server	172
5-3	TEC console sample in summery chart view	173

Tables

1-1	Cluster domain characteristics	6
1-2	Fileset name installed by default	9
2-1	Base data types	21
2-2	Four groups of resource managers	23
2-3	Terms used by ERRM	24
3-1	Values for the new condition	76
4-1	CT_MANAGEMENT_SCOPE	97

Notices

This information was developed for products and services offered in the U.S.A.

IBM may not offer the products, services, or features discussed in this document in other countries. Consult your local IBM representative for information on the products and services currently available in your area. Any reference to an IBM product, program, or service is not intended to state or imply that only that IBM product, program, or service may be used. Any functionally equivalent product, program, or service that does not infringe any IBM intellectual property right may be used instead. However, it is the user's responsibility to evaluate and verify the operation of any non-IBM product, program, or service.

IBM may have patents or pending patent applications covering subject matter described in this document. The furnishing of this document does not give you any license to these patents. You can send license inquiries, in writing, to:

IBM Director of Licensing, IBM Corporation, North Castle Drive Armonk, NY 10504-1785 U.S.A.

The following paragraph does not apply to the United Kingdom or any other country where such provisions are inconsistent with local law: INTERNATIONAL BUSINESS MACHINES CORPORATION PROVIDES THIS PUBLICATION "AS IS" WITHOUT WARRANTY OF ANY KIND, EITHER EXPRESS OR IMPLIED, INCLUDING, BUT NOT LIMITED TO, THE IMPLIED WARRANTIES OF NON-INFRINGEMENT, MERCHANTABILITY OR FITNESS FOR A PARTICULAR PURPOSE. Some states do not allow disclaimer of express or implied warranties in certain transactions, therefore, this statement may not apply to you.

This information could include technical inaccuracies or typographical errors. Changes are periodically made to the information herein; these changes will be incorporated in new editions of the publication. IBM may make improvements and/or changes in the product(s) and/or the program(s) described in this publication at any time without notice.

Any references in this information to non-IBM Web sites are provided for convenience only and do not in any manner serve as an endorsement of those Web sites. The materials at those Web sites are not part of the materials for this IBM product and use of those Web sites is at your own risk.

IBM may use or distribute any of the information you supply in any way it believes appropriate without incurring any obligation to you.

Information concerning non-IBM products was obtained from the suppliers of those products, their published announcements or other publicly available sources. IBM has not tested those products and cannot confirm the accuracy of performance, compatibility or any other claims related to non-IBM products. Questions on the capabilities of non-IBM products should be addressed to the suppliers of those products.

This information contains examples of data and reports used in daily business operations. To illustrate them as completely as possible, the examples include the names of individuals, companies, brands, and products. All of these names are fictitious and any similarity to the names and addresses used by an actual business enterprise is entirely coincidental.

COPYRIGHT LICENSE:

This information contains sample application programs in source language, which illustrates programming techniques on various operating platforms. You may copy, modify, and distribute these sample programs in any form without payment to IBM, for the purposes of developing, using, marketing or distributing application programs conforming to the application programming interface for the operating platform for which the sample programs are written. These examples have not been thoroughly tested under all conditions. IBM, therefore, cannot guarantee or imply reliability, serviceability, or function of these programs. You may copy, modify, and distribute these sample programs in any form without payment to IBM for the purposes of developing, using, marketing, or distributing application programs conforming to IBM's application programming interfaces.

Trademarks

The following terms are trademarks of the International Business Machines Corporation in the United States, other countries, or both:

AIX®

AIX 5L™

DB2®

DB2 Universal Database™

e (logo)® 

IBM®

pSeries™

Redbooks™

Redbooks (logo)™ 

RS/6000®

SP™

Tivoli®

Tivoli Enterprise™

Tivoli Enterprise Console®

The following terms are trademarks of other companies:

ActionMedia, LANDesk, MMX, Pentium and ProShare are trademarks of Intel Corporation in the United States, other countries, or both.

Microsoft, Windows, Windows NT, and the Windows logo are trademarks of Microsoft Corporation in the United States, other countries, or both.

Java and all Java-based trademarks and logos are trademarks or registered trademarks of Sun Microsystems, Inc. in the United States, other countries, or both.

C-bus is a trademark of Corollary, Inc. in the United States, other countries, or both.

UNIX is a registered trademark of The Open Group in the United States and other countries.

SET, SET Secure Electronic Transaction, and the SET Logo are trademarks owned by SET Secure Electronic Transaction LLC.

Other company, product, and service names may be trademarks or service marks of others.

Preface

This redbook discusses the capabilities of Resource Monitoring and Control (RMC) that enables you to monitor various resources of your system and create automated responses to changing conditions of those resources.

RMC is provided by the AIX 5L Version 5.1 and later operating systems and is a subset of the functionality available in Reliable Scalable Cluster Technology (RSCT). RSCT provides a set of software components that together support a powerful and flexible environment for clustering systems.

The focus of this redbook is to explain the architecture and components of RMC and its usage by providing with practical examples in several different configurations, including:

- ▶ Introduction
- ▶ Architecture and components
- ▶ Quick start: using RMC
- ▶ RMC command line interface
- ▶ Monitoring applications

This redbook is an ideal desk side reference for IBM employees, Business Partners, and customer system administrators or technical specialists who exploit RMC to manage IBM @server pSeries servers running AIX 5L Version 5.1.

The team that wrote this redbook

This redbook was produced by a team of specialists from around the world working at the International Technical Support Organization, Austin Center.

Keigo Matsubara is an advisory IT specialist at the International Technical Support Organization (ITSO), Austin Center. Before joining the ITSO, he worked in the System and Web Solution Center in Japan as a Field Technical Support Specialist (FTSS) for pSeries. He has been working for IBM for ten years.

Bruno Blanchard is a Certified IT Specialist working for IBM France at the IGS Pan-EMEA Infrastructure & Technology group, in La Gaude. He holds an Engineer Degree from Ecole Centrale de Paris and a Master of Science degree from Oregon State University. He has been with IBM since 1983, as a system

engineer for VM and AIX. He is a certified AIX and SP specialist, and his areas of expertise also include pSeries servers and clusters, as well as network management. He is currently working as an architect in projects deploying clusters of IBM RS/6000 SP and IBM @server pSeries 690 servers.

Peter Nutt is a Senior IT Specialist working in IBM UK for the advanced technical support group. He has 26 years of experience in the IT industry with 14 years working in the UNIX operating system field. He has worked at IBM for two years and his areas of expertise include programming, problem determination, application porting, and real-time systems. This is his second redbook.

Mamoru Tokuyama is an IT Specialist working in the System and Web Solution Center in Japan as a FTSS for pSeries. He holds a certified advanced technical expert of AIX and has more than seven years experience in AIX and SP area. He has been working for IBM for 12 years.

Tomoyuki Nijima is an advisory IT architect in ERM service/BIS/IGS in IBM Japan. He has more than 10 years experience in AIX. This is his second redbook.

Thanks to the following people for their contributions to this project:

International Technical Support Organization, Austin Center

Edson Manoel, Luis Ferreira, Wade Wallace

IBM Austin

Julie Craft and Yoichiro Ishii

IBM Japan

Kenji Matsuo

IBM Poughkeepsie

Alice Hackett, Gina Yuan, Joseph Chaky, Marcene Stewart-Hill, Michael Schmidt, Margaret Moran, Mike Stancampiano, Myung Bae, Ning-Wu Wang, Susan Yang, Timothy B Flaherty, Ya-Huey Juan

Thanks to the following organization for their contributions to this project:

IBM Japan Systems Engineering Co., Ltd. Data Systems

Become a published author

Join us for a two- to six-week residency program! Help write an IBM Redbook dealing with specific products or solutions, while getting hands-on experience

with leading-edge technologies. You'll team with IBM technical professionals, Business Partners and/or customers.

Your efforts will help increase product acceptance and customer satisfaction. As a bonus, you'll develop a network of contacts in IBM development labs, and increase your productivity and marketability.

Find out more about the residency program, browse the residency index, and apply online at:

ibm.com/redbooks/residencies.html

Comments welcome

Your comments are important to us!

We want our Redbooks to be as helpful as possible. Send us your comments about this or other Redbooks in one of the following ways:

- ▶ Use the online **Contact us** review redbook form found at:

ibm.com/redbooks

- ▶ Send your comments in an Internet note to:

redbook@us.ibm.com

- ▶ Mail your comments to:

IBM Corporation, International Technical Support Organization
Dept. JN9B Building 003 Internal Zip 2834
11400 Burnet Road
Austin, Texas 78758-3493



Introduction

Resource Monitoring and Control (RMC) is a function that gives you the ability to monitor the state of system resources and respond when predefined thresholds are crossed, so that you can perform many routine tasks automatically.

In AIX 5L Version 5.1 and later, RMC is a no charge feature installed by default upon the operating system installation; you can use RMC on a stand-alone system immediately after the installation to monitor your systems.

This chapter includes the following sections:

- ▶ Section 1.1, “What is RMC” on page 2
- ▶ Section 1.2, “The evolution of RMC” on page 4
- ▶ Section 1.3, “Clustered environment” on page 5
- ▶ Section 1.4, “RMC software packaging” on page 8

1.1 What is RMC

What does RMC do? It is a frequently asked question and the answer is that RMC is a no charge feature of AIX 5L Version 5.1 that can be configured to monitor *resources* (disk space, CPU usage, processor status, application processes, and so on) and perform an *action* in *response* to a defined *condition*.

Note: The following sections explain several terms used in RMC:

- ▶ Section 2.2, “Resource, resource class, and attribute” on page 19
- ▶ Section 2.4, “Expression” on page 30
- ▶ Section 2.5, “Condition, response, and action” on page 30

For example, you can configure RMC to automatically expand a file system if its usage exceeds 95 percent. The flexibility of RMC enables you to configure response actions or scripts that manage general system conditions with little or no involvement from the administrator.

AIX 5L Version 5.1 provides more than 80 predefined conditions that can be activated for monitoring with just a few mouse clicks in the Web-based System Manager or a few commands from the command prompt.

These conditions range from “/tmp space used” to “Token ring transmit overflow rate” and can be used as soon as AIX 5L Version 5.1 is installed and running. The predefined conditions are ready to use and just need to be enabled or configured to match the exact requirements of your systems. If predefined conditions do not satisfy your systems’ requirements, RMC allows you to create new conditions, responses, and actions to tailor the system to respond when and how you require.

Technically, Resource Monitoring and Control (RMC) is a subset function of Reliable Scalable Cluster Technology (RSCT). Figure 1-1 on page 3 shows an overview of the AIX cluster architecture, and the components highlighted by the ellipse offers the RMC function.

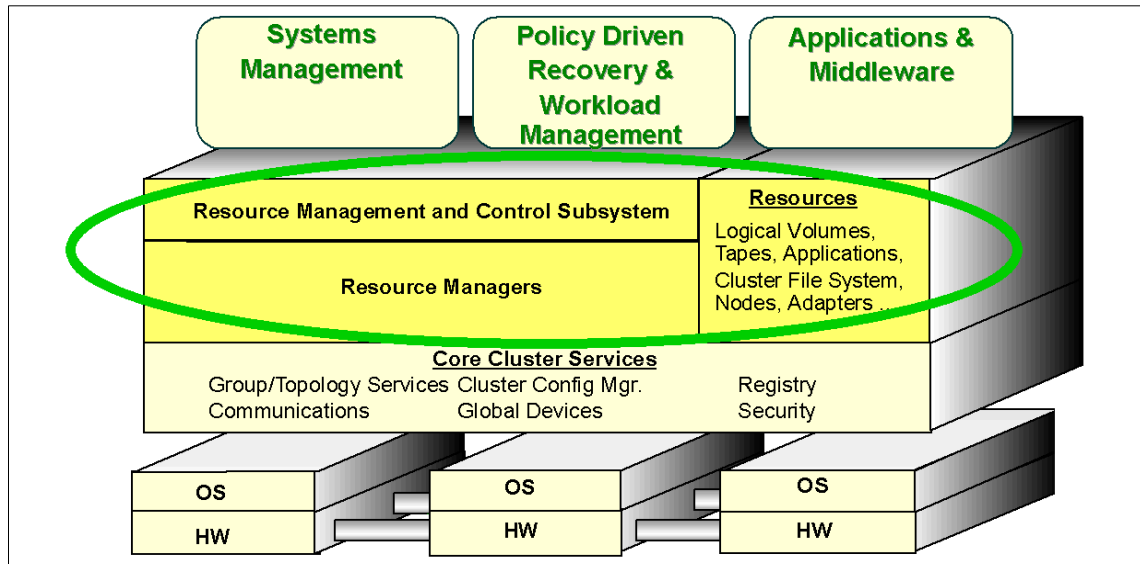

Figure 1-1 Overview of AIX cluster architecture

The term Resource Monitoring and Control (RMC) is used as part of one of the following terms to explicitly refer to the function or the component, depending on the context:

RSCT RMC A subset function of Reliable Scalable Cluster Technology (RSCT) that is provided by the components highlighted by the ellipse in Figure 1-1.

RMC subsystem A daemon (ctrmc) provided in AIX 5L Version 5.1 that provides services to the other RSCT RMC components. It is shown as “Resource Monitoring and Control Subsystem” in Figure 1-1.

These terms are further explained in the following publications:

- ▶ *IBM RSCT for AIX: Messages, GA22-7891*
- ▶ *IBM RSCT for AIX: Guide and Reference, SA22-7889*
- ▶ *IBM RSCT for AIX: Technical Reference, SA22-7890*

However, we use the term RMC to refer to the first meaning throughout this redbook. If we have to refer to the ctrmc daemon (subsystem), we use the term *RMC subsystem*.

1.2 The evolution of RMC

Technically, Resource Monitoring and Control (RMC) is a subset of Reliable Scalable Cluster Technology (RSCT). The functions provided by RSCT were historically known as the *High Availability* (HA) components of Parallel System Support Program (PSSP), which is a separately purchase-able software product. PSSP is used on the RS/6000 Scalable Parallel (SP) and the IBM @server Cluster 1600.

The initial use of PSSP was for high performance computing systems using IBM RS/6000 Scalable Parallel (SP) systems, where the only way to satisfy the computing (or I/O) requirement was to exploit parallelism and spread the workload over multiple systems. The PSSP suite includes a number of modules, and together, these modules have the functionality to provide a set of high availability services and facilities ideally suited for building and maintaining large configurations of servers. Following the initial use of PSSP in the scientific computing area, it became apparent that this capability could be used to satisfy the growing requirements in the commercial market place and, through time, modules that proved to be useful in general computing were migrated into standard tools, such as RMC, to be used on any pSeries servers. In contrast, however, SP specific functionality has been retained within PSSP.

Following the evolution path discussed earlier, it can be seen that while RMC is a new facility in AIX 5L Version 5.1, the functionality has been previously available through PSSP and the RSCT components, and the major difference in AIX 5L Version 5.1 is the exposure of the control mechanisms to the users.

When associated with AIX Version 4, PSSP included RSCT Version 1.2.1 as separate filesets to provide the required cluster functionality.

Starting with AIX 5L Version 5.1, RSCT is no longer included in a separate software product, and is included in the operating system as a standard feature. If PSSP is installed, the RSCT provided by AIX 5L Version 5.1 is used for cluster operations.

Because of the history of RSCT, all the components, including Topology Service (TS), Group Service (GS), and Event Monitoring (HAEM), provided by the former versions of PSSP, which include RSCT, have been well documented in many IBM publications in several years. In this context, Topology Service and Group Service are as follows:

Topology Services A distributed subsystem of RSCT that provides node reachability, adapter status information, and a reliable messaging service to other high availability subsystems.

Group Services A subsystem of RSCT that provides a distributed synchronization and coordination service to other high availability subsystems.

You may be interested in RSCT architecture and user interface, because RMC uses TS and GS. We recommend you refer to the following IBM Redbooks for further detail about RSCT:

- ▶ *GPFS on AIX Clusters: High Performance File System Administration Simplified*, SG24-6035
- ▶ *PSSP Version 3 Survival Guide*, SG24-5344
- ▶ *RS/6000 SP Cluster: The Path to Universal Clustering*, SG24-5374
- ▶ *RSCT Group Services: Programming Cluster Applications*, SG24-5523

1.3 Clustered environment

RMC is capable of working in a stand-alone¹ or *clustered* environment. In AIX 5L Version 5.1, nodes in a cluster may be configured for either of the following cluster domains:

- ▶ Peer domain
- ▶ Management domain

The general difference between them is the relationship between the nodes. In a peer domain, all nodes are considered equal and any node can monitor and control (or be monitored and controlled) by any other node. In a management domain, a management node is aware of all nodes it is managing but the nodes themselves know nothing of each other.

Except for the fact that the GUI and CLI must run from the management server in a management domain, the functionality between the two domain types (as well as a stand-alone system) is identical.

Please refer to Table 1-1 on page 6 for further detailed differences between the two domain types.

¹ If you use RMC on a stand-alone system, you do not need to perform any cluster configuration.

Table 1-1 Cluster domain characteristics

Peer domain	Management domain
Established and administered by configuration resource manager (see Section 2.3.3, “Configuration resource manager” on page 27).	Established and administered by the IBM Cluster Systems Management product (CSM). CSM also provides two additional resource managers—the domain resource manager (DMSRM) on management server and the CSM agent resource manager (CSM Agent RM) on managed nodes.
Has a number of nodes that are all equal; there is no distinguished or master node. All nodes are aware of all other nodes, and administration commands can be issued from any node in the domain. All nodes have a consistent view of the domain membership.	Has a management server that is used to administer a number of managed nodes. Only management servers have knowledge of the whole domain. Managed nodes only know about the servers managing them. Managed nodes know nothing of each other.
Processor architecture and operating system are homogeneous.	Processor architecture and operating system are heterogeneous.
The RMC subsystem and core resource managers are used to manage cluster resources.	The RMC subsystem and core resource managers are used by CSM to manage cluster resources.
RSCT cluster security services are used to authenticate other parties.	RSCT cluster security services are used to authenticate other parties.
The Topology Services subsystem provides node/network failure detection.	The Topology Services subsystem is <i>not</i> needed.
The Group Services subsystem provides cross node/process coordination.	The Group Services subsystem is <i>not</i> needed.

1.3.1 Peer domain

To configure a peer domain, you have to do the following:

1. Install the required filesets, as explained in Section 1.4, “RMC software packaging” on page 8.
2. Set up the cluster, as explained in Section 4.3, “A peer domain cluster setup” on page 106.

Figure 1-2 on page 7 shows the relationship between nodes in a peer domain with four nodes.

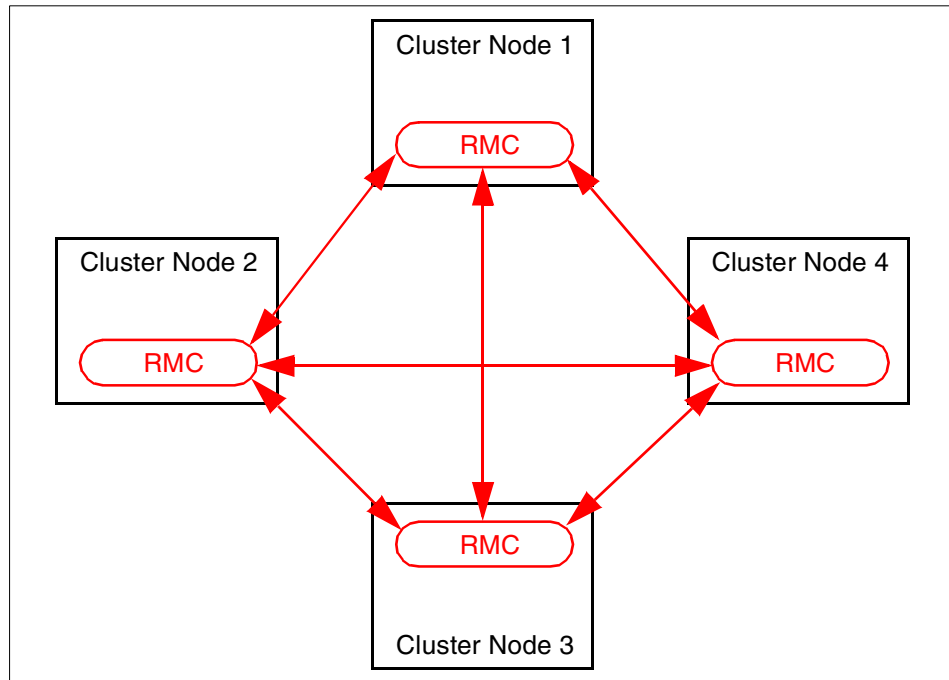

Figure 1-2 Peer domain cluster topology

1.3.2 Management domain

The management domain is provided for use by the IBM Cluster Systems Management (CSM) product,² but the operation and capabilities of RMC are the same as the peer domain. At the time of writing this redbook, this mode is only used with CSM.

In a management domain, nodes are managed by a management server.³ The management server is aware of all the nodes it manages and all managed nodes are aware of their management server. However, the managed nodes know nothing about each other.

Figure 1-3 on page 8 shows the relationship between nodes in a management domain.

² At the time of writing this redbook, the CSM product is available on the Linux operating system only.

³ The management server can be a cluster node at the same time.

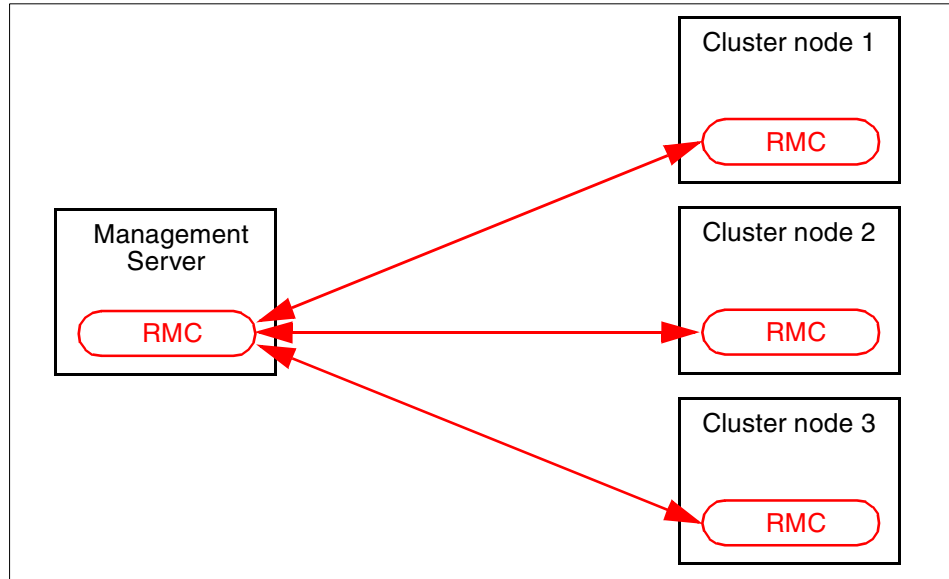

Figure 1-3 Management domain cluster topology

For further information about CSM, please refer to *Linux Clustering with CSM and GPFS*, SG24-6601.

1.4 RMC software packaging

The RMC components⁴ required for a stand-alone configuration are installed automatically upon the AIX 5L Version 5.1 installation by default; therefore, once the AIX 5L Version 5.1 installation is complete, RMC will be active and ready to be used. However, no resources will be monitored or controlled until you have configured the system to do so.

For systems that do not require cluster operation, no further filesets are required. If you are creating a peer domain cluster on an AIX 5L Version 5.1 system, you must install the following three filesets in addition to those filesets installed by default:

- ▶ rsct.basic.rte
- ▶ rsct.compat.basic.rte
- ▶ rsct.compat.clients.rte

⁴ We recommend that you apply the latest fileset updates even if you use RMC in a stand-alone environment only.

Note: These filesets are included in the AIX 5L Version 5.1 installation media.

1.4.1 Filesets and packages

Upon installation of AIX 5L Version 5.1, the filesets⁵ shown in Table 1-2 are installed by default.

Table 1-2 Fileset name installed by default

Fileset name	Description
rsct.core.rmc	RSCT Resource Monitoring and Control
rsct.core.sr	RSCT Registry
rsct.core.errm	RSCT Event Response Resource Manager
rsct.core.auditrm	RSCT Audit Log Resource Manager
rsct.core.fsrn	RSCT File System Resource Manager
rsct.core.hostrm	RSCT Host Resource Manager
rsct.core.utils	RSCT Utilities
rsct.core.gui	RSCT Graphical User Interface
rsct.core.sec	RSCT Security

These fileset names are included in the system bundle file `/usr/sys/inst.data/sys_bundles/MIN_BOS.autoi`, and are to be installed upon installation of AIX 5L Version 5.1, as shown in the following example:

```
# pwd
/usr/sys/inst.data/sys_bundles
# grep -i rsct *
MIN_BOS.autoi:I:rsct.core.rmc
MIN_BOS.autoi:I:rsct.core.sr
MIN_BOS.autoi:I:rsct.core.errm
MIN_BOS.autoi:I:rsct.core.auditrm
MIN_BOS.autoi:I:rsct.core.fsrn
MIN_BOS.autoi:I:rsct.core.hostrm
MIN_BOS.autoi:I:rsct.core.utils
MIN_BOS.autoi:I:rsct.core.gui
MIN_BOS.autoi:I:rsct.core.sec
```

For cluster configurations in a peer domain (see Section 4.3, “A peer domain cluster setup” on page 106), you need to ensure that the latest `rsct.basic.rte`

⁵ This list does not contain message catalog filesets, such as `rsct.msg.en_US.core.rmc`.

fileset is installed on your system. If you find that no cluster management commands are present on your system, this may be the cause.

If the `rsct.basic.rte` fileset is not shown in the output of `ls1pp -L "rsct.*"` on your system, then do the following:

1. Install the `rsct.basic.rte` fileset (base fileset) from the AIX 5L Version 5.1 CD-ROM media.
2. Install AIX 5L Version 5.1 recommended maintenance level (RML) 2.
3. Apply APAR IY30258.

At the end of this step, your system should have the fileset levels shown in Appendix A, "Filesets level information" on page 175.

You should verify that some sub-systems are running on your system, as shown in the following example:

```
# lssrc -g rsct; lssrc -g rsct_rm
Subsystem      Group      PID      Status
ctcas          rsct       16516    inoperative
ctrmc          rsct       21942    active
Subsystem      Group      PID      Status
IBM.CSMAgentRM rsct_rm    21180    active
IBM.ERRM       rsct_rm    19162    active
IBM.ServiceRM6 rsct_rm    18072    active
IBM.AuditRM    rsct_rm    22458    active
```

The subsystems shown as *active* in this example should be active on any AIX 5L Version 5.1 systems without being customized.

Installing the `rsct.rmc.sensorrm` fileset

RMC provides the capability to monitor your own resources by using *sensor* scripts or programs. Before attempting to configure this capability, you have to check that the fileset `rsct.core.sensorrm` is installed.

Note: The `rsct.core.sensorrm` fileset is *not* installed upon the AIX 5L Version 5.1 installation by default.

If the `rsct.core.sensorrm` fileset is not shown in the output of `ls1pp -L "rsct.*"` on your system, do the following:

1. Install the `rsct.core.sensorrm` fileset (base fileset) from the AIX 5L Version 5.1 CD-ROM media.

⁶ The `IBM.ServiceRM` resource manager is included in the `devices.chrp.base.ServiceRM` fileset and installed on the `chrp` architecture machine type only.

2. Install AIX 5L Version 5.1 recommended maintenance level (RML) 2.
3. Apply IY30258.

By default, the IBM.SensorRM sub-system is not started. It will be started by the RMC subsystem only when resources managed by IBM.SensorRM are referenced. To check if the sub-system is working correctly, execute the **lsrsrc IBM.Sensor** command, then execute the **lssrc** commands, as shown in Example 1-1; the IBM.SensorRM subsystem should be active after this operation.

Example 1-1 No IBM.SensorRM sub-system

```
# lspp -L | grep sensor
  rsct.core.sensorrm      2.2.1.10  C    F    RSCT Sensor Resource Manager
# lssrc -g rsct; lssrc -g rsct_rm
```

Subsystem	Group	PID	Status
ctrmc	rsct	20124	active
ctcas	rsct	18842	active
Subsystem	Group	PID	Status
IBM.ERRM	rsct_rm	21442	active
IBM.ServiceRM	rsct_rm	21702	active
IBM.CSMAgentRM	rsct_rm	22468	active
IBM.AuditRM	rsct_rm	4704	active
IBM.SensorRM	rsct_rm	20400	active

If it is not still active, do the following:⁷

1. Stop RMC daemons:

```
# /usr/sbin/rsct/bin/rmcctrl -z
```

2. Reconfigure necessary information and start RMC daemons:

```
# /usr/sbin/rsct/bin/rmcctrl -A
```

3. Restart the sensor subsystem:

```
# lsrsrc IBM.Sensor
```

Then you should see the IBM.SensorRM sub-system is running on your system and ready to use the sensor function.

For further information about sensor, see the following sections:

- ▶ Section 4.7, “Sensor commands” on page 122
- ▶ Section 5.2, “Advanced monitoring” on page 156

⁷ This step will update the configuration database to enable IBM.SensorRM.

1.4.2 Uninstall RMC from your system

In some circumstances, you may want to uninstall all the RMC filesets. For example, if you are setting up an AIX system that is directly connected to the Internet and installed with a firewall software, you might be requested to close unused TCP/IP ports and to remove all the files, which are not necessary by this installation.

Note: We strongly recommend that you do *not* uninstall RMC from your system, unless you understand what you are going to do and have a strong reason to do so, because some AIX features, such as Service Focal Point, depend on RMC. If you want to turn off TCP port 657 for use by the RMC subsystem, you can execute `rmcctr1 -P`, although it also prevents AIX features relying on RMC from correctly working.

To remove all the RMC filesets, execute the following command:

```
# installp -ug rsct.*
```

The following filesets, which are depending on RMC, are also uninstalled at the same time:

bos.clvm.enh	5.1.0.10
csm.client	1.1.0.1
devices.chrp.base.ServiceRM	1.1.0.0

The command also remove all files and directories under the `/var/ct` directory.

1.4.3 Reinstall RMC on your system

To reinstall all the RMC filesets, do the following:

1. Install the following filesets from the AIX 5L Version 5.1 CD-ROM media:

- rsct.core.rmc
- rsct.core.sr
- rsct.core.errm
- rsct.core.auditrm
- rsct.core.fsrn
- rsct.core.hostrn
- rsct.core.utils
- rsct.core.gui
- rsct.core.sec
- rsct.compat.*
- csm.client
- devices.chrp.base.ServiceRM

2. Install AIX 5L Version 5.1 recommended maintenance level (RML) 2.
If applying of the 2.2.0.10 level of the rsct.core.sr files set should fail, then run the command again.
3. Apply IY30258.



Architecture and components

This chapter briefly explains the architecture and the components of Resource Monitoring and Control (RMC) and provides you with the background information you need to quickly set up the monitoring functions on a stand-alone pSeries server or a cluster of pSeries servers.

To explain the architecture and the components, this chapter includes the following six sections:

- ▶ Section 2.1, “A glance at the architecture” on page 16
- ▶ Section 2.2, “Resource, resource class, and attribute” on page 19
- ▶ Section 2.3, “Resource managers” on page 23
- ▶ Section 2.4, “Expression” on page 30
- ▶ Section 2.5, “Condition, response, and action” on page 30
- ▶ Section 2.6, “Directory structure used by RMC” on page 35

2.1 A glance at the architecture

Resource Monitoring and Control (RMC) is a subset of Reliable Scalable Cluster Technology (RSCT), where the *CT* in RSCT means Cluster Technology. Although you can also use RMC to monitor resources on a stand-alone pSeries, the architecture allows the following functions to be supported on clusters:

- ▶ Provide single monitoring and management infrastructure for clusters.
- ▶ Provide global access to subsystems and resources throughout the cluster.
- ▶ Support operations for configuring, monitoring, and controlling all cluster resources by RMC clients.
- ▶ Encapsulate all resource dependent operations.
- ▶ Provide a common access control mechanism across all resources.
- ▶ Support integration with other subsystems to achieve the highest levels of availability.

To support these functions, the structure of the RSCT Resource Monitoring and Control is not simple, as shown in Figure 2-1.

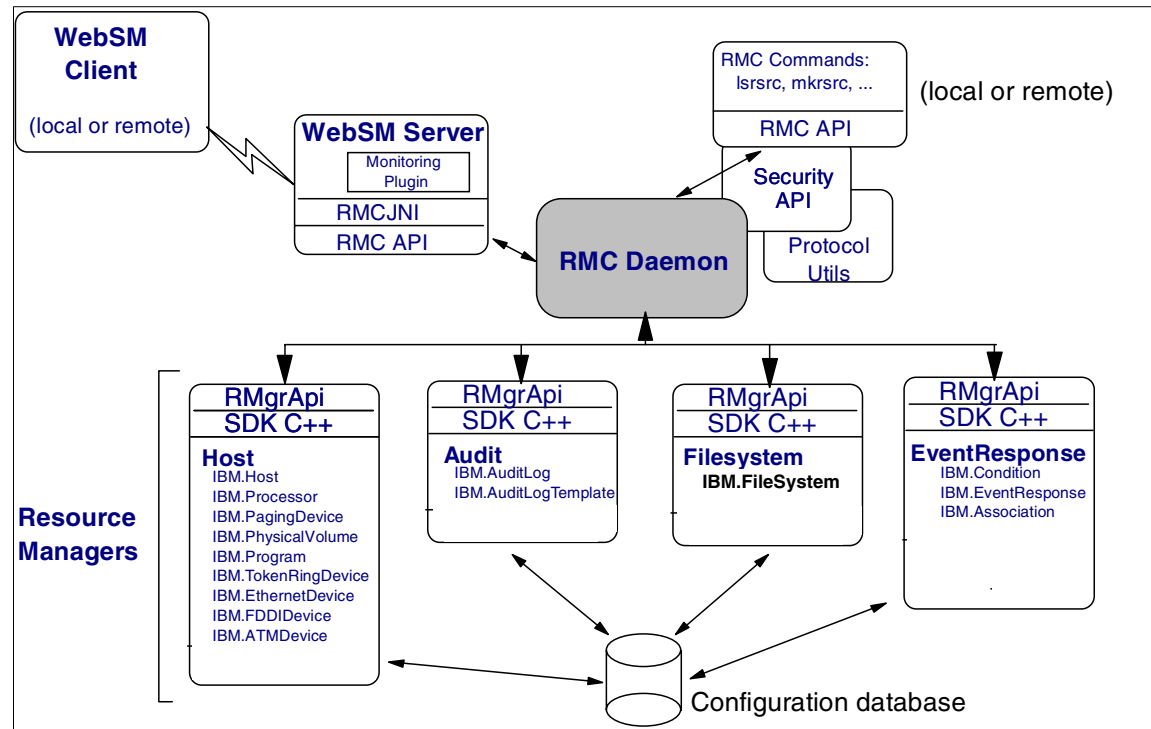

Figure 2-1 Detailed relationship between RMC components and clients

The purpose of this redbook is not to describe the technical internal implementation specifics of RMC; therefore we briefly explain Figure 2-1 on page 16 in the following list:

- ▶ The RMC subsystem is the core of RSCT Resource Monitoring and Control. It is a generic component that provides a scalable and reliable backbone to its clients with an interface to resources. It has no knowledge of resource implementations, characteristics, or features. The RMC subsystem therefore delegates to resource managers the actual execution of the actions the clients ask to perform.
- ▶ The RMC subsystem and RMC clients (see Section 2.1.1, “RMC clients” on page 17) need not be in the same node. RMC provides a distributed service to its clients. The RMC clients can connect to the RMC daemon either locally or remotely using the RMC API (Resource Monitoring and Control application user interface).
- ▶ The RMC subsystem and the Resource Managers (see Section 2.3, “Resource managers” on page 23) it interacts with need not be in the same node. If they are on different nodes, the RMC subsystem will interact with the RMC subsystem located locally on the same node as the resource managers, then the local RMC daemon will forward the request between them.
- ▶ Each resource manager is instantiated as one AIX process. To avoid the multiplication of processes, a resource manager can handle several resource classes.
- ▶ Many commands of the command line interface are Korn shell or Perl scripts: the end-user can have a look at them and use them as samples for writing his own commands. This will be explained in Chapter 4, “RMC command line interface” on page 93.

For further information about the architecture of RMC, please refer to the following publications:

- ▶ *IBM RSCT for AIX: Guide and Reference, SA22-7889*
- ▶ *IBM RSCT for AIX: Technical Reference, SA22-7890*

2.1.1 RMC clients

Although there are several RMC client implementations available, we explain the following two types of interface⁸ only for RMC clients in this redbook:

- ▶ Command line interface (CLI)
- ▶ Graphical user interface (GUI)

⁸ You cannot use SMIT to interact with RMC.

Throughout this redbook, we refer to both the interfaces as *RMC clients*. Figure 2-2 illustrates the relationship between the RMC subsystem and its clients. A RMC command line client can access all the resources within a cluster locally (A) and remotely (B). A RMC GUI (WebSM) client also can access all the resources within a cluster locally (D) and remotely (C), but the access path is different between these two interfaces.

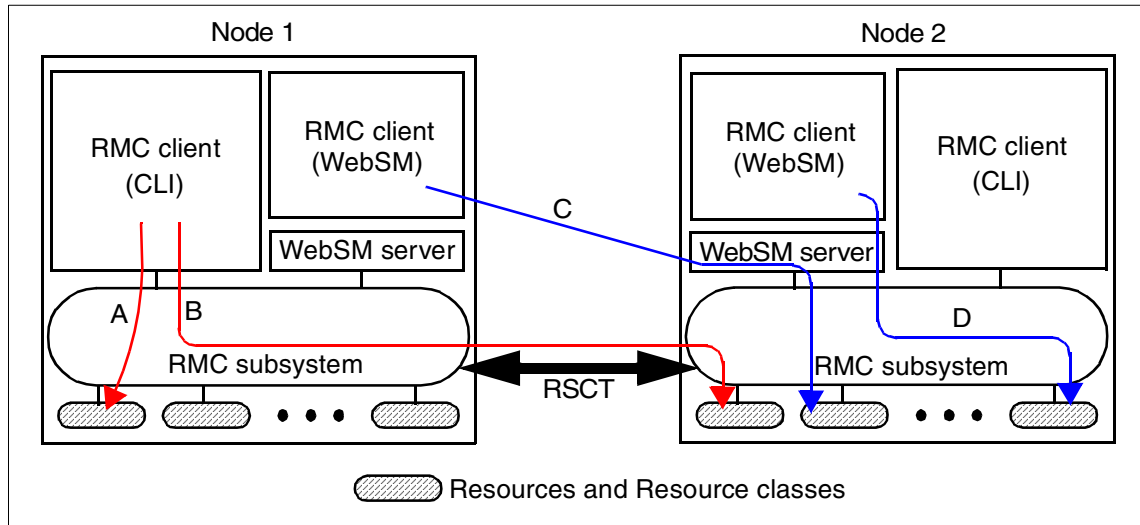

Figure 2-2 Relationship between RMC clients and RMC sub systems

Command line interface (CLI)

The RMC command line interface is comprised of more than 50 commands: some components, such as Audit Log resource manager, have only two commands, while others, such as Event Response resource manager, have 15 commands.

Most RMC commands provide you with a similar look and feel. Many commands have optional arguments to instruct, the command same functions. In addition to command optional arguments, RMC defines two environment variables, CT_CONTACT and CT_MANAGEMENT_SCOPE. These variables instruct most⁹ RMC commands to define their target and scope upon retrieving and setting values among cluster nodes.

Finally, RMC has a concept of *Resource Data Input*, which is a standardized file format for holding resource properties. Many RMC commands have a -f option that allows the end user to pass arguments to the command through a file

⁹ The CT_CONTACT and CT_MANAGEMENT_SCOPE environment variables are not necessarily supported by all commands.

instead of typing them on the command line. These files have the same Resource Data Input format for all commands so that the same file can be used for different commands. Two commands (**lsrsrcdef** and **lsactdef**) can generate such a file so their output can be used as input for other commands.

Chapter 4, “RMC command line interface” on page 93 contains a number of examples showing how to use RMC commands.

For further information about RMC command line interface, please refer to the *IBM RSCT for AIX: Technical Reference*, SA22-7890.

Graphical user interface (GUI)

The RMC graphical user interface is provided by the Web-based System Manager, as explained in Chapter 3, “Quick start: using RMC” on page 37.

Note: Web-based System Manager does not generate the command line history, which can be produced in the `smit.script` file by SMIT, upon execution of operation tasks, this is because Web-based System Manager directly connects to RMC and does not invoke any commands.

2.2 Resource, resource class, and attribute

This section provides you with the three terms used in RMC: resource, resource class, and attribute, as illustrated in Figure 2-3 on page 20. You have to understand these terms explained in this section before performing any configuration and monitoring tasks using RMC.

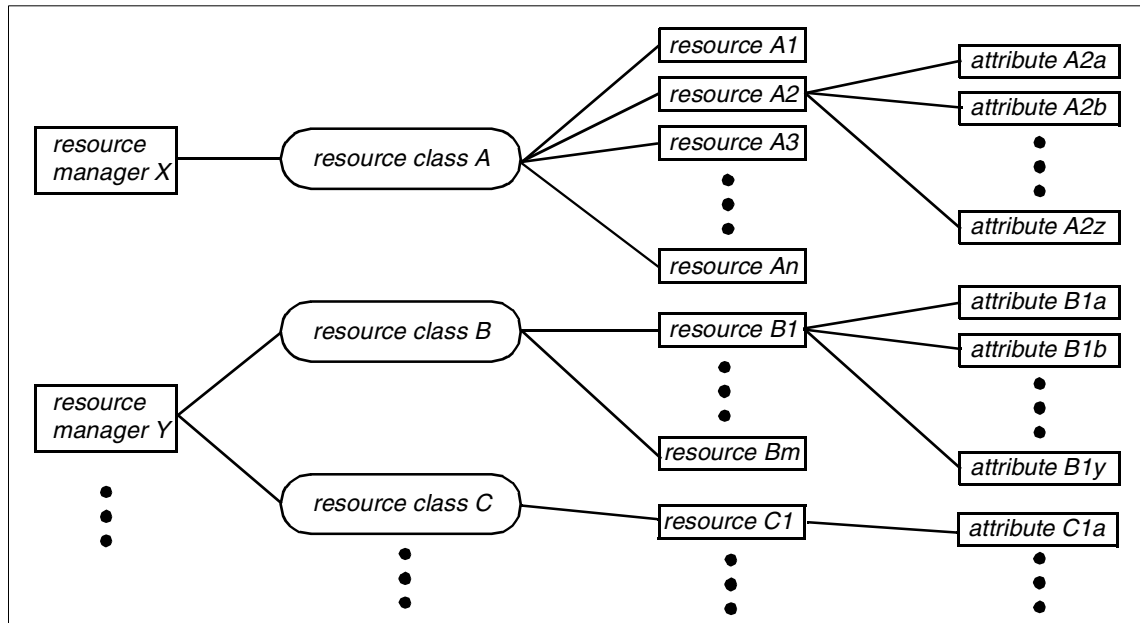

Figure 2-3 Resource managers, resource classes, resources, and attributes¹⁰

2.2.1 Resource

The *resource* is a fundamental concept in the RMC architecture. A resource is an abstraction of an instance of a physical or logical entity that provides services to applications or system components. A system or cluster is composed of numerous resources of various types.

For example, the `/var` and the `/tmp` file systems are represented as two different resources in RMC.

Each resource has the following characteristics:

- ▶ An operational interface that is used by its clients. This interface is the reason for the resource's existence. For example, the operational interface of a logical volume is the standard open, close, read, and write system calls.
- ▶ A set of persistent data values called persistent attributes, which describe the characteristics or configuration of the resource. For example, the file system name, logical volume name, and so on.

¹⁰ Although a resource class also has its own attributes, as explained in Section 2.2.2, "Resource class" on page 21, this figure does not show the relationship between a resource class and its attributes on purpose.

- ▶ A set of dynamic data values called dynamic attributes, which reflect the current state or other measurement values of the resource. For example, the disk block usage of a file system.
- ▶ A handle that uniquely identifies the resource within the cluster. This value is unique across time and space and is called a resource handle.
- ▶ A set of operations that manipulate the state or configuration of the resource.

2.2.2 Resource class

A *resource class* is a collection of resources that have similar characteristics. The resource class provides descriptive information about the properties and characteristics that are common to any resource within the resource class.

For example, all the file system resources, such as /var and /tmp, belong to the file system resource class in RMC.

Each resource class has the following characteristics:

- ▶ Descriptive information about the class and its resources.
- ▶ A list of the resource handles for all existing resources within the class.
- ▶ A set of persistent data values called persistent attributes that describe or control the operation of the resource class.
- ▶ A set of dynamic data values called dynamic attributes. For example, every resource class supports a dynamic attribute that changes whenever the number of resources in the class changes.
- ▶ An access control list (ACL) that defines permissions that authorized users have for manipulating or querying the resource class.
- ▶ A set of operations to modify or query the resource class.

2.2.3 Attribute

A resource class and a resource have several *attributes*. An attribute has a value and a unique name within the resource class or the resource. The attribute value is stored in the one of the base data types shown in Table 2-1.

Table 2-1 Base data types

Symbolic name	Description
CT_INT32	Signed 32-bit integer
CT_UINT32	Unsigned 32-bit integer
CT_INT64	Signed 64-bit integer

Symbolic name	Description
CT_UINT64	Unsigned 64-bit integer
CT_FLOAT32	32-bit floating point
CT_FLOAT64	64-bit floating point
CT_CHAR_PTR	Null-terminated string
CT_BINARY_PTR	Binary data—arbitrary-length block of data
CT_RSRC_HANDLE_PTR	Resource handle—an identifier for a resource that is unique over space and time (20 bytes)

In addition to the base data types, an attribute value can be stored in one of the two aggregate data types: array or structured data (SD). The elements of the aggregate types array and SD are of the basic types, and arrays of SD and SD that contains arrays are also supported. However, SD may not contain SD nor arrays of SD.

A resource attribute is classified into either a *public* or a *private* property. The property is used as a hint for the RMC client for whether the attribute is to be presented to general users. Private attributes typically contain information that is not relevant to general users; therefore, the private attributes are hidden by default. However, you can display private attributes by specifying a flag in the command. Web-based System Manager does not support the display or modification of private resource attributes.

Attributes fall into two categories: *persistent* and *dynamic*. Each category has a different role, and is used differently by RMC clients.

Note: The provided set of attributes is static. You cannot add or remove any attributes from resources or resource classes, except for the sensor resource class.

Persistent attributes

For resources, persistent attributes are configuration parameters and are set either by the resource monitor harvesting real resources, or through the **mkrsrc** or the **chrsrc** commands. Persistent attributes define the characteristics of the resource. Examples of persistent attributes are Device Name, IP Address, and so on.

For resource classes, persistent attributes describe or control the operations of the class.

For the RMC client, the main usage of persistent resources are to specify which resources will be accessed. They are used as filters over the set of managed resources to select those on which the client wants to act.

For example, all the file system resources have the persistent attribute *Dev*, which is supplied by the file system resource manager and derived from the *dev* attribute in the */etc/filesystems* file for the target file system.

Dynamic attributes

Dynamic attributes reflect internal states or performance variables of resources and resource classes. For example, all the file system resources have dynamic attributes such as, operational state, % total used, % inode used, and so on.

You generally refer to dynamic attributes to define the monitoring condition of the resource you want to monitor. For example, if you want to monitor a file system resource, you can monitor the disk space usage of the file system.

2.3 Resource managers

Each resource manager is the interface between the RMC subsystem and a specific aspect of the AIX instance it is controlling. All resource managers have the same architecture and interact with the other RMC components. However, due to their specific nature, they have different usage for the end user.

For the purpose of this redbook (which only addresses monitoring), we categorizes them into the four groups (shown in Table 2-20, according to their function.

Table 2-2 Four groups of resource managers

Major functions ▶ Resource manager name	Description
Logging and debugging ▶ Audit Log resource manager	The Audit Log resource manager is used by other RMC components to log information about their actions, errors, and so on. The typical end user of Audit Log resource manager is a system administrator who scans these logs to see what is happening in the various RMC components. Unless a problem occurs, there is generally no need for the user to look at these logs.
Configuration ▶ configuration resource manager	The configuration resource manager is used by the system administrator to configure the system in a Peer Domain cluster. It is not used when RMC is configured in Standalone or Management Domain nodes.

Major functions	Description
<ul style="list-style-type: none"> ▶ Resource manager name 	
Reacting to events <ul style="list-style-type: none"> ▶ Event Response resource manager 	The Event Response resource manager is the only resource manager that is directly used by end users in normal operation conditions. Interfaces (GUI or CLI) allow the end user to define which events he wants to monitor in the nodes, and how the system should react to these events.
Monitoring data <ul style="list-style-type: none"> ▶ File system resource manager ▶ Host resource manager ▶ Sensor resource manager 	This group contains the file system resource manager, the Host resource manager, and the Sensor resource manager. They can be seen by the end user as the containers of the objects and variables to monitor. However, it is important to note that these resource managers have no user interface. The end user cannot ^a interact directly with them and has to pass through the Event Response resource manager to access the resources managed by these resource managers.

a. The only exception is the Sensor resource manager. It is the only resource manager that provides for expandability. Its user interface therefore contains four commands to let the end user define, modify or delete resources to be monitored. Once these resources are created, the normal interface to them is, through the Event Response resource manager.

As of the writing of this redbook, RMC has the six resource managers explained in the following sections:

- ▶ Section 2.3.1, “Event Response resource manager (ERRM)” on page 24
- ▶ Section 2.3.2, “Audit Log resource manager” on page 26
- ▶ Section 2.3.3, “Configuration resource manager” on page 27
- ▶ Section 2.3.4, “File system resource manager” on page 28
- ▶ Section 2.3.5, “Host resource manager” on page 28
- ▶ Section 2.3.6, “Sensor resource manager” on page 29

Note: The number of resource managers provided by AIX can be changed in accordance with future AIX development.

2.3.1 Event Response resource manager (ERRM)

The Event Response resource manager plays the most important role to monitor systems using RMC. It uses the several terms, listed in Table 2-3.

Table 2-3 Terms used by ERRM

Term	Relevant explanation
Action	Section 2.5.2, “Action” on page 32
Condition	Section 2.5.1, “Condition” on page 30
Expression	Section 2.4, “Expression” on page 30

Term	Relevant explanation
Response	Section 2.5.3, "Response" on page 33

The Event Response resource manager provides the system administrator with the ability to define a set of conditions to monitor in the various nodes of the cluster, and to define actions to take in response to these events. The conditions are applied to dynamic properties of any resources of any resource manager in the cluster. The Event Response resource manager provides a simple automation mechanism for implementing event driven actions. Basically, you can do the following:

- ▶ Define a condition that is composed of a resource property to be monitored and an expression that is evaluated periodically.
- ▶ Define a response that is composed of zero or more actions that consists of a command to be run and controls, such as to when and how the command is to be run.
- ▶ Associates one or more responses with a condition and activates the association.

In addition:

- ▶ Different users can use the same conditions and responses, and mix and match them to build different monitoring scenarios.
- ▶ Many predefined conditions and responses are shipped with the system and can be used as templates for the user who wants to define his own monitoring scenarios.
- ▶ Any events that occur and any responses that are run are logged in the audit log. You can look at the audit log to check that the defined conditions were triggered, how the system reacted, and what was the result of the actions.

The Event Response resource manager provides you with both a CLI and a GUI (Web-based System Manager). Because RMC comes with a predefined set of conditions, actions, and responses, we recommend you start by combining some of these into associations using the Web-based System Manager, and to then use the CLI display commands (starting with `ls...`) to see the results of these combinations.

You can then decide whether you want to use the Web-based System Manager or the CLI. In a stand-alone environment and for setting up limited monitoring of the resources, the Web-based System Manager is the easiest tool to use, unless you are already familiar with the CLI commands and arguments. However, for managing a cluster or developing sophisticated monitoring scenarios, we recommend you to write your own shell scripts calling the CLI commands.

Examples of the GUI and CLI are presented in Chapter 3, “Quick start: using RMC” on page 37 and Chapter 4, “RMC command line interface” on page 93.

2.3.2 Audit Log resource manager

The Audit Log resource manager provides the other RMC subsystems with an extra logging facility, in addition to the standard AIX errorlog and syslog. It can be seen as a means to trace the various actions that were taken by the RSCT subsystem.

Note: There is no relationship between the RMC audit log function and the AIX security audit function. The RMC audit log does not replace either the AIX errorlog or the syslog.

Typically, these subsystems will add entries in the audit log corresponding to their normal behavior or to error cases. Examples of information provided in the audit log are:

- ▶ Instances of starting and stopping monitoring
- ▶ Events
- ▶ Actions taken in response to events
- ▶ Results of these actions
- ▶ Subsystem errors and monitoring errors

Only subsystems can add records to the audit log; there is no user interface that allows the end user to add entries in the audit log.

Only two actions are offered to you by the Audit Log resource manager:

lsaudrec Lists records in the audit log.

rmaudrec Deletes the specified records in the audit log.

Web-based System Manager provides you with the same function provided by these two CLI commands.

It must be clear to you that the Audit Log is different from the logs that are used by the logevent action. The logevent action cannot be used to add entries in the audit log, and the **lsaudrec** and **rmaudrec** commands cannot be used to handle the logs used by the logevent action, which are handled by the AIX **alog** command. Similarly, the **lsaudrec** and **rmaudrec** commands cannot be used to examine either the AIX errorlog or syslog. See Section 4.9, “Audit Log commands” on page 142, for the usage of these commands.

Because the RMC audit log function is implemented as a resource manager, all actions allowed on RMC resources are also available to handle resources of the Audit Log resource manager. Hence, it is also possible to monitor these resources through the Event Response resource manager features. It is possible, for example, to take an action each time a new entry is created in the Audit Log, by monitoring the RecordsAdded attribute of an AuditLog resource. However, this is not recommended, because it can easily result in an infinite loop of producing events and audit log records each other.

2.3.3 Configuration resource manager

The configuration resource manager can create and manage a peer domain cluster. Therefore, you do not have to use the configuration resource manager to use RMC on a stand-alone server or in a management domain with CSM.

However, if you want to configure peer domains, you have to understand the following concepts:

Peer domain A peer domain is a set of nodes that share the same high availability services (Topology and Group Services). It is also often referred to as an RSCT cluster. From an RMC point of view, all nodes in a peer domain are equivalent, and RMC commands can be executed from any node with any other node (or nodes) as the target. A peer domain can be online or offline, which corresponds to turning on or off the RSCT high availability services.

Node A node can belong to several peer domains: it can be part of the definition of multiple peer domains. However, at one point in time, the node can only belong to at most one *online* peer domain. Membership to a peer domain is a dynamic feature. A node can be added or removed to existing peer domains.

Security Since remote commands can be executed between nodes in the peer domain, authentication and authorization mechanisms are provided with RMC to ensure that only nodes that have been authorized by the system administrator to participate in the domain can use these remote commands. The authentication and authorization mechanisms must be configured on each node before it can join a peer domain.

Quorum The notion of quorum is used to ensure that in case of loss of connectivity between two subsets of the peer domain, only one subset considers itself as the peer domain. The quorum is defined as $n/2+1$, where n is the number of nodes defined in the peer domain. A peer domain cannot be turned online if less than the quorum of nodes can communicate.

For further explanation about the peer domain and management domain, see the following sections:

- ▶ Section 1.3, “Clustered environment” on page 5.
- ▶ Section 4.3, “A peer domain cluster setup” on page 106

2.3.4 File system resource manager

The File system resource manager manages only one resource class: the local file systems on the cluster node. It can be used to list the file systems, get their status, and retrieve values like the percentage of used space or inodes.

2.3.5 Host resource manager

The host resource manager gives you the possibility to monitor hardware devices and programs running on the cluster nodes. The monitored hardware include processors, memory, paging space, disks, and network interface adapters. The program monitoring feature allows you to monitor when processes executing any arbitrary program are created or destroyed.

The host resource manager manages the following 10 resource classes¹¹, as shown in Figure 2-1 on page 16:

- ▶ Host (IBM.Host)
This resource class externalizes the properties of a machine that is running a single copy of an operating system. Primarily the properties included are those that are advantageous in predicting or indicating when corrective action needs to be taken.
- ▶ Paging device (IBM.PagingDevice)
This resource class externalizes the properties of paging devices.
- ▶ Physical volume (IBM.PhysicalVolume)
This resource class externalizes many properties of disks, such as the number of I/Os, wait time, and so on.
- ▶ Processor (IBM.Processor)
This resource class externalizes the properties of individual processors, such as idle time and time spent in the kernel.
- ▶ Host Public (IBM.HostPublic)
This resource class gives information on the local host’s identifier token taken from the key files.

¹¹ The notation used in here is “generic name (resource class name)”.

- ▶ Program (IBM.Program)

This resource class allows a client to monitor properties of a program that is running on a host. The program to monitor is identified by properties such as program name, arguments, and so on. The resource class does not monitor processes as such, because processes are very transient and therefore inefficient to monitor individually.

A practical example for the IBM.Program resource class is given in Section 5.1, “How to monitor DB2 Universal Database” on page 152.

- ▶ ATM device (IBM.ATMDevice)

All ATM adapters installed in a node are externalized through this resource class.

- ▶ Ethernet device (IBM.EthernetDevice)

All Ethernet adapters installed in a node are externalized through this resource class.

- ▶ FDDI device (IBM.FDDIDevice)

All FDDI adapters installed in a node are externalized through this resource class.

- ▶ Token-Ring device (IBM.TokenRingDevice)

All Token-Ring adapters installed in a node are externalized through this resource class.

The last four resource classes are used for representing the corresponding network type adapters.

2.3.6 Sensor resource manager

The sensor resource manager allows the user to extend the functionality of RMC for monitoring parts of the AIX environment for which RMC does not provide a predefined resource class or attribute.

The sensor resource manager provides four commands to create, rename, or remove new resources called sensors. A sensor is a command that will be periodically executed, returning a value that can be monitored by defining a condition in the ERRM. By default, the period of execution is 60 seconds, but this period can be set up by the user to another value when creating the sensor.

If more than one returned value is needed, it is possible to define sensors returning multiple “property = value” pairs. This feature can be used, for example, to implement behaviors, such as notify root user of the value of properties 2 and 3 when property 1 exceeds a threshold.

For further explanation about the usage of sensor resource manager commands, see the following sections:

- ▶ Section 4.7, “Sensor commands” on page 122
- ▶ Section 5.2, “Advanced monitoring” on page 156

2.4 Expression

The expression is the means of making computations with the data stored in attributes and audit log record fields. An expression is composed of variables, constants, and operators, and returns a boolean value: *true* or *false*.

The same syntax is used regardless of the following three environments; however, the expressions handle different types of variable:

ERRM conditions	Trigger events based on dynamic attributes of resources.
GUI or CLI	Filter resources based on variables representing persistent attributes of the resources.
Audit log: expressions	Select audit records with variables being the name of a record field.

The following sections provides ample examples how to use expressions:

- ▶ Section 4.2, “Common variables and command flags” on page 95
- ▶ Section 4.8, “ERRM commands” on page 126

2.5 Condition, response, and action

This section explains the following terms used in RMC: condition, expression, response, and action. You have to understand these terms before configuring any monitoring tasks using RMC.

2.5.1 Condition

A condition applies to a resource class. It may contain a selection string, which is used to define which resource in the resource class should be monitored. It also contains a boolean expression that must be satisfied by one (and only one) dynamic attribute of the resource to fire the condition. A condition has a name, so the user can refer to it once defined. A condition can also contain an optional rearm expression.

For example, to see if the /tmp file system uses more than 90 percent of its available disk space, a predefined condition called “/tmp space used” is provided with RMC. This condition uses the file system resource class (IBM.FileSystem), and uses the selection string:

```
"Name == \"/tmp\""
```

to select only the /tmp file system from all of the file systems of the monitored nodes. It contains the expression “PercentTotUsed > 90”, which applies to the PercentTotUsed attribute of the file system resource.

Note: The selection string is optional. If not present, all resources in a resource class are selected.

A condition can also contain a node group list that the event is monitored on. The default value for the node group list is NULL for all the nodes within the management scope. The default value for the management scope is local scope for the local node.

Figure 2-4 on page 32 illustrates the relationship between the monitored resource(s), conditions, events, and rearm events.

A condition can specify multiple monitored resources selected from a resource class by the selection string. A condition cannot select resources selected from multiple resource classes. Multiple conditions can specify the same resource(s); however, they must have different condition names. If multiple conditions that specify the same resource(s) have the same expression or the rearm expression, then they define the same event or the rearm event. However, you may want to specify different actions for them.

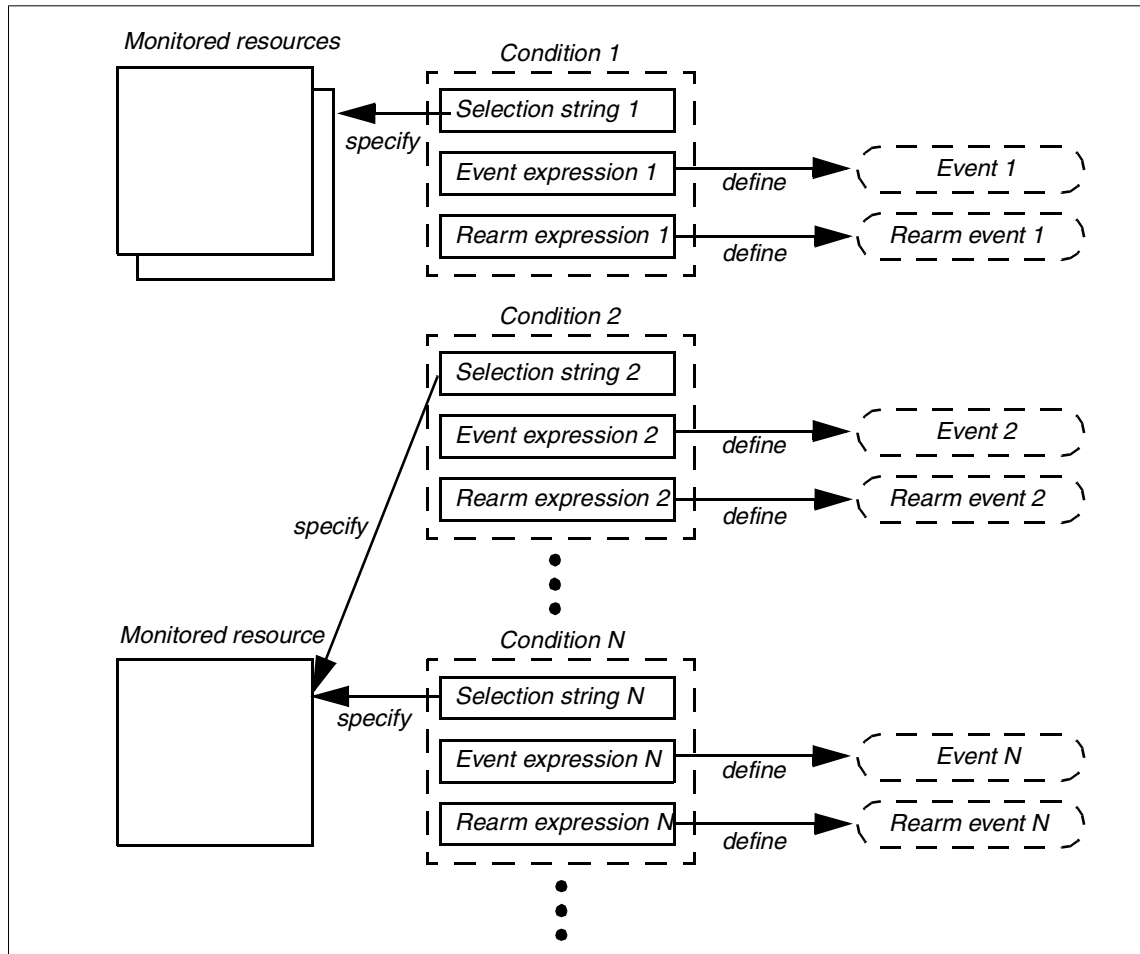

Figure 2-4 Condition, expression, and events

Note: There are no objects defined as event and rearm event. If an event expression is evaluated as true, the result is called as an event. If a rearm expressions evaluated as true, the result is called as a rearm event.

2.5.2 Action

RMC comes with three predefined actions: `logevent`, `notifyevent`, and `wallevent`.

- ▶ The `logevent` action appends a formatted string to a user defined log file that can be read later on using the `alog` command.

- ▶ The `notifyevent` action sends the content of the event to a user specified user ID using e-mail.
- ▶ The `wallevent` event broadcasts a message to all users using the `wall` command.

There are two variations of these actions, called `elogevent`, `enotifyevent`, and `ewallevent`, with the same functionality as the previous actions; however, these *e-version* actions always return messages in English, while the messages of the original three actions will depend upon the locale settings.

You can specify an action when it should be executed from the following cases:

- ▶ Only when the event defined by the associated condition occurs.
- ▶ Only when the rearm event defined by the associated condition occurs.
- ▶ Either the event or the rearm event defined by the associated condition occurs.

Finally, the user can also provide customized scripts as actions and the existing Korn shell scripts can be used as examples or starting points for more complex operations. The user defined scripts are executed in an environment where variables are set according to the event that would trigger the action. For example, the `ERRM_RSRC_NAME` variable would contain the name of the resource whose dynamic attribute change caused an event to fire.

For a complete list of the available environment variables, please refer to the *IBM RSCF for AIX: Guide and Reference, SA22-7889*.

Note: Do not confuse the actions used as part of a response with the actions that are part of a class or resource.

2.5.3 Response

A response is a set of zero¹² or more actions that will be performed by the system when an expression of a condition evaluates to true. A response contains the following information on how the actions are executed:

- ▶ Arguments for the actions.
- ▶ Time ranges (periods) to describe when the action can be run.
- ▶ Definitions of environment variables to set before executing the action.
- ▶ The expected return code of the action and if the results of the action should be directed, for example, to the audit log.

¹² A response can contain no action if you just want to see the event log to AuditLog without running any actions.

In AIX 5L Version 5.1, RMC provides eight predefined responses (see Figure 3-12 on page 51). A response can be defined with multiple actions. For example, the critical notification response calls the following three predefined actions:

- ▶ Logging an entry in the `/tmp/criticalEvents.log`
- ▶ Sending e-mail to the root user
- ▶ Warning all logged use with `wall` event

2.5.4 Association between a condition with a response

Conditions and responses can exist without being used and with nothing related to each other. Actions are part of responses and only defined to responses. Although it is possible that multiple responses have an action using the same name, these actions do not refer to the same object. You can associate a response with multiple actions.

To start observing the monitored resource, a condition must be associated with at least one response. You can associate a condition with multiple responses. However, each pair of a condition and a response is considered a separate association. Once associated, the condition and response should be activated (started).

Note: Throughout this redbook, we use a term, “condition and response”, to express an association between a condition and a response.

Figure 2-5 on page 35 illustrates the relationship between the conditions, the responses, and the actions. In this figure, there are three associations (A, B, and C).

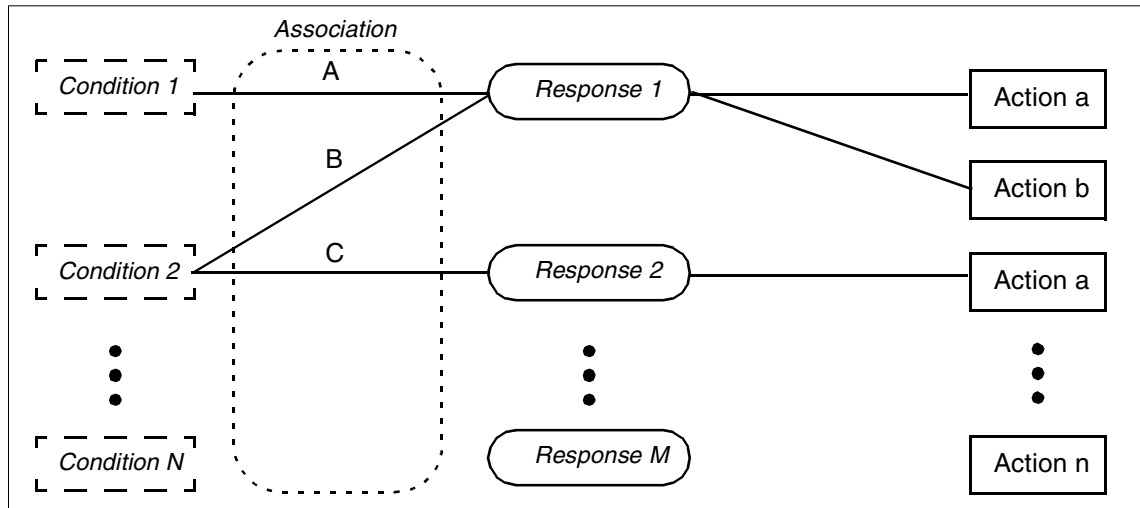

Figure 2-5 Conditions, responses, and actions

Note: The association has no name. The labels A, B, and C are for reference purposes. To refer to the specific association, you have to specify the condition name and the response name that make the association. For example, you have to specify the condition 1 and the response 1 to refer to the association A. Also, it must be clear that the same action name (in this example, action a) can be used in multiple responses, but these actions are different objects.

2.6 Directory structure used by RMC

RMC uses two major directories, `/usr/sbin/rsct` and `/var/ct`, to store files and data. Although there are many directories and files under them, the following list gives you a brief explanation about the directory structure used by RMC.

Note: Most RSCT commands are symbolic-linked in the `/usr/bin` directory. If you cannot find some RSCT commands, invoke them by adding `/usr/sbin/rsct/bin` to the command search path (`$PATH`).

`/var/ct`

Contains general information about the status and operation of RSCT (log files and so on). Also holds user specified security configuration files.

`/var/ct/IW`

Files relevant to the IW (Independent Workstation) mode of operation (stand-alone, not clustered). If in a

cluster, relevant files will be in `/var/ct/<cluster_id>`, where `cluster_id` cannot be `IW`. The file `IW` is a symbolic link to a representation of the cluster ID, which is shown as a string of alphanumeric characters. All nodes in the same domain have the same cluster ID.

<code>/var/ct/<cluster_id></code>	Contains information (log files and so on) about the cluster <i>cluster_id</i> .
<code>/usr/sbin/rsct</code>	Repository for configuration and utility files.
<code>/usr/sbin/rsct/README</code>	Useful README files for RSCT that are recommended reading for users of RSCT RMC.
<code>/usr/sbin/rsct/bin</code>	General RSCT binary files and predefined action scripts.
<code>/usr/sbin/rsct/cfg</code>	Contains general configuration and default security configuration files.
<code>/tmp/ctsupt</code>	Directory for diagnostic dump files for problem determination and analysis (log files, trace information, and so on). Data is generated by <code>/usr/sbin/rsct/bin/ctsnap</code> and is only collected from the invoking node.

Note: Many log files are stored under the `/var/ct` directory and their size can grow during normal system activity. To ensure trouble free operation, check that `/var` has available free space at all times. The predefined condition “`/var space used`” can be used to monitor the status and to provide a suitable automated response.

For further information about directories and files used by RMC, please refer to the *IBM RSCT for AIX: Technical Reference, SA22-7890*.



Quick start: using RMC

Resource Monitoring and Control (RMC) provides a highly flexible infrastructure to monitor and control AIX 5L Version 5.1 systems in either a stand-alone or a clustered environment.

This chapter explains how to use RMC in a stand-alone environment along with several examples using Web-based System Manager. It includes the following four sections:

- ▶ Section 3.1, “AIX 5L Version 5.1 Web-based System Manager” on page 38
- ▶ Section 3.2, “RMC setup procedure” on page 45
- ▶ Section 3.3, “Customizing your RMC configuration” on page 57
- ▶ Section 3.4, “Creating a new condition or response” on page 70

For the usage of RMC in a cluster environment, see Chapter 4, “RMC command line interface” on page 93.

Note: All the graphical images contained in this chapter are based on information that was available no later than June 2002. The detailed filesets level used in our test are shown in Appendix A, “Filesets level information” on page 175.

3.1 AIX 5L Version 5.1 Web-based System Manager

AIX 5L Version 5.1 Web-based System Manager provides an easy to use graphical user interface (GUI) with a familiar look and feel interface to users who have experienced working on a personal computer (PC), to be used for configuration and system management tasks. Web-based System Manager is installed, by default, upon AIX 5L Version 5.1 installation and is ready to use as soon as the system is available.

Web-based System Manager supports the following operation modes:

- ▶ Stand-alone application mode
- ▶ Client-Server mode
- ▶ PC applet mode
- ▶ PC client mode

To start Web-based System Manager in the stand-alone application mode¹³, which invokes the application on the local X Window system, just type `wsm&` on the command prompt. You will see the application window, as shown in Figure 3-1 on page 39.

¹³ The stand-alone application mode requires that a graphics display be equipped with the AIX system.

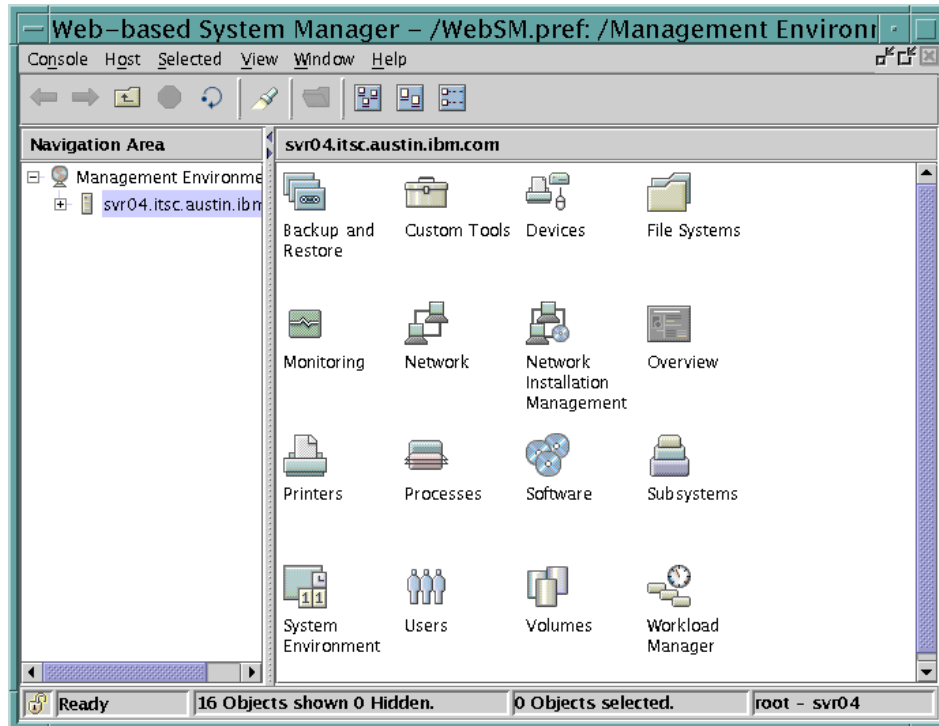

Figure 3-1 AIX 5L Version 5.1 Web-based System Manager

Note: To use Web-based System Manager in the stand-alone application mode, no configuration is necessary.

If you are using the Common Desktop Environment (CDE), you can also start Web-based System Manager using the following steps:

1. Select the Application Manager icon in the CDE front panel
2. Select the System_Admin icon
3. Select the Management Console icon

The following URL gives you a brief explanation about Web-based System Manager in AIX 5L Version 5.1:

<http://www-1.ibm.com/servers/aix/os/wsm/51/>

For further information about Web-based System Manager, please refer to the following online publications:

- ▶ *AIX 5L Version 5.1 System Management Guide*
- ▶ *AIX 5L Version 5.1 Web-based System Manager Administration Guide*

Note: Throughout the rest of this redbook, we only use the PC client mode, because Web-based System Manager provides the same GUI for all the operation modes.

3.1.1 Enable remote Web-based System Manager access

To use Web-based System Manager in one of the following operation modes:

- ▶ Client-Server mode
- ▶ PC applet mode
- ▶ PC client mode

you have to configure the target AIX system to be remotely managed. To enable remote Web-based System Manager access, install the `wsm_remote` bundle on the system as the root user.

3.1.2 Install Web-based System Manager PC client

Once you have installed AIX 5L Version 5.1, the *PC client* for Web-based System Manager is ready to be downloaded. You can download the PC client into your PC system by accessing the URL

`http://host_name/pc_client/pc_client.html`, where `host_name` is the host name of the AIX 5L Version 5.1 system.

Once the installation has finished, you will see the following icon placed on your Windows desktop:



Now you can connect to AIX 5L Version 5.1 systems using the Web-based System Manager PC client by double-clicking this icon.

3.1.3 Connect to AIX 5L Version 5.1 system using the PC client

To connect to an AIX 5L Version 5.1 system using the Web-based System Manager PC client, do the following:

1. Double-click the “Web-based System Manager PC client” icon. You will see the Log On dialog box shown in Figure 3-2.

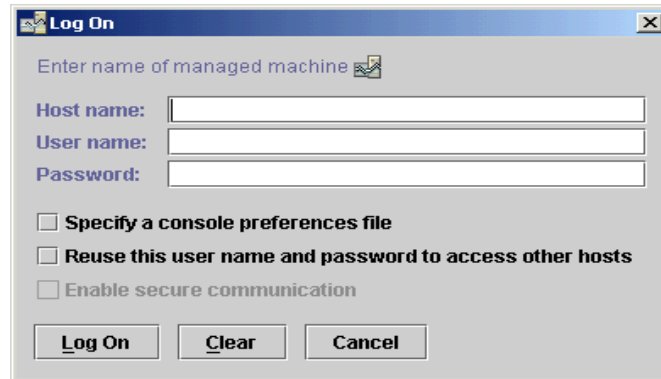

Figure 3-2 Log On dialog box

2. Enter the target AIX system’s host name in the dialog box.
3. Once the host name has been validated, enter the user name and password in the Log On dialog box, then click Log On.

If the user name and password you supplied in this panel is authenticated by the target AIX system, the connection is established successfully. After authentication, the granted access is classified into the following two privileges, depending on the supplied user name:

root	Full read and write access to the system settings.
non-privileged	Read access only to the system settings. User can do monitoring.

4. Then the Web-based System Manager window displays the target host name to be managed on the window title; the host name is also highlighted in the Navigation Area and the status bar, as shown in Figure 3-3 on page 42.

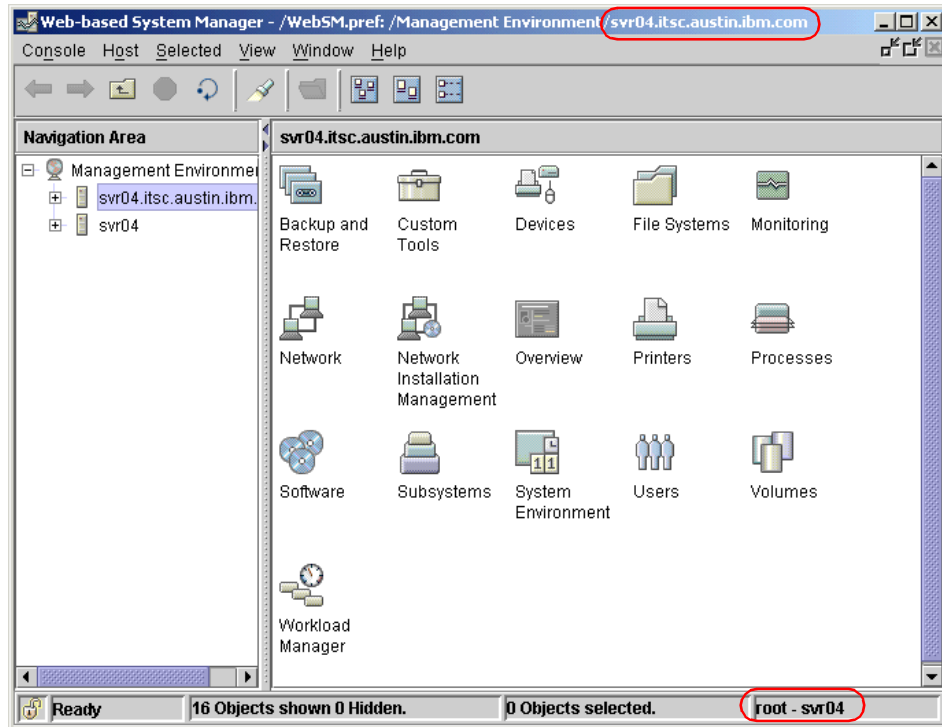

Figure 3-3 The Web-based System Manager window

3.1.4 Connections to multiple hosts

You can also manage multiple hosts from a Web-based System Manager window. To connect multiple hosts, do the following steps:

1. Select **Console** -> **Add** -> **Hosts...**
2. Enter the host name or the IP address in the text field highlighted in Figure 3-4 on page 43, and click Add.

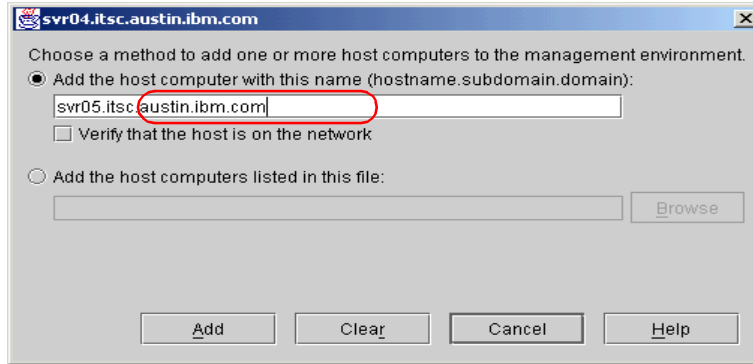

Figure 3-4 Adding hosts to the management environment

Once a host is added, it will appear under the Management Environment tree in the Navigation Area, as shown in Figure 3-5.

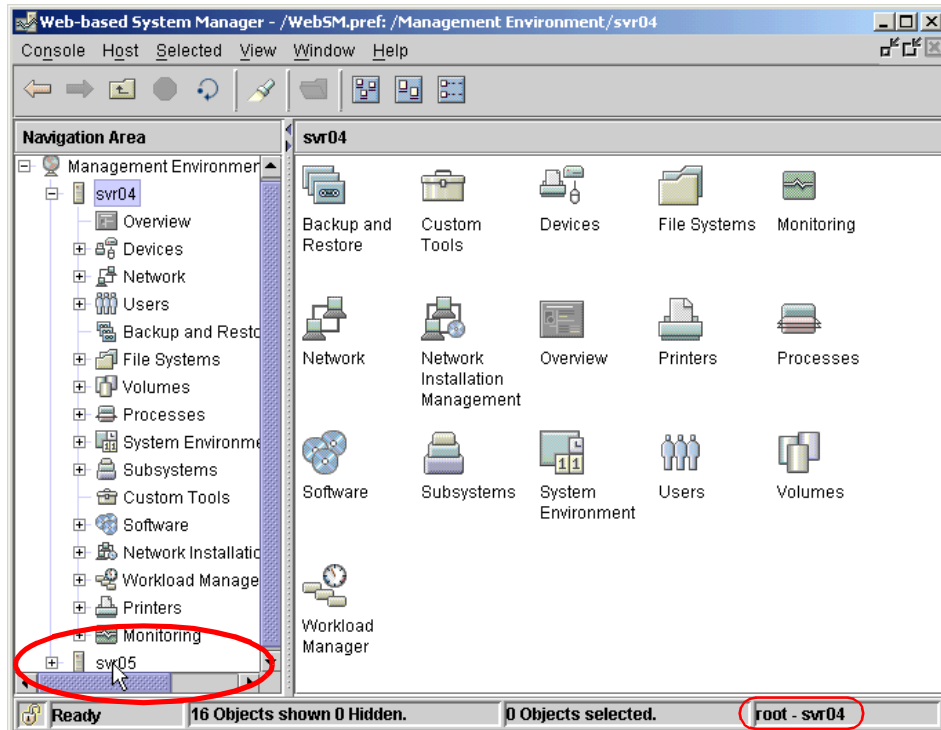

Figure 3-5 Selecting a host to manage

3. To connect to this host, select the host icon and then double-click. A Log On panel will appear that requests you to enter a user name and password, as shown in Figure 3-6.

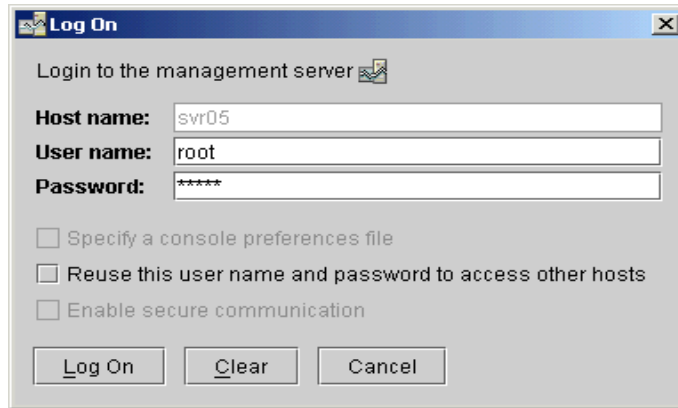

Figure 3-6 Log On window

When you are managing multiple hosts, you can display both hosts in a Web-based System Manager window by using a tiled display. To use a tiled display, first add a new window by selecting **Window -> New Window** and then select **Window -> Tile Vertically**, as shown in Figure 3-7 on page 45.

Once you have multiple windows displayed, select the window that represents the host you want to manage by clicking the relevant window. The managed host name is shown in the sub-window title bar and also shown as the highlighted icon in the Management Area pane in each sub-window. The highlighted title bar and the status bar indicate which host is currently being managed (in this example, svr04).

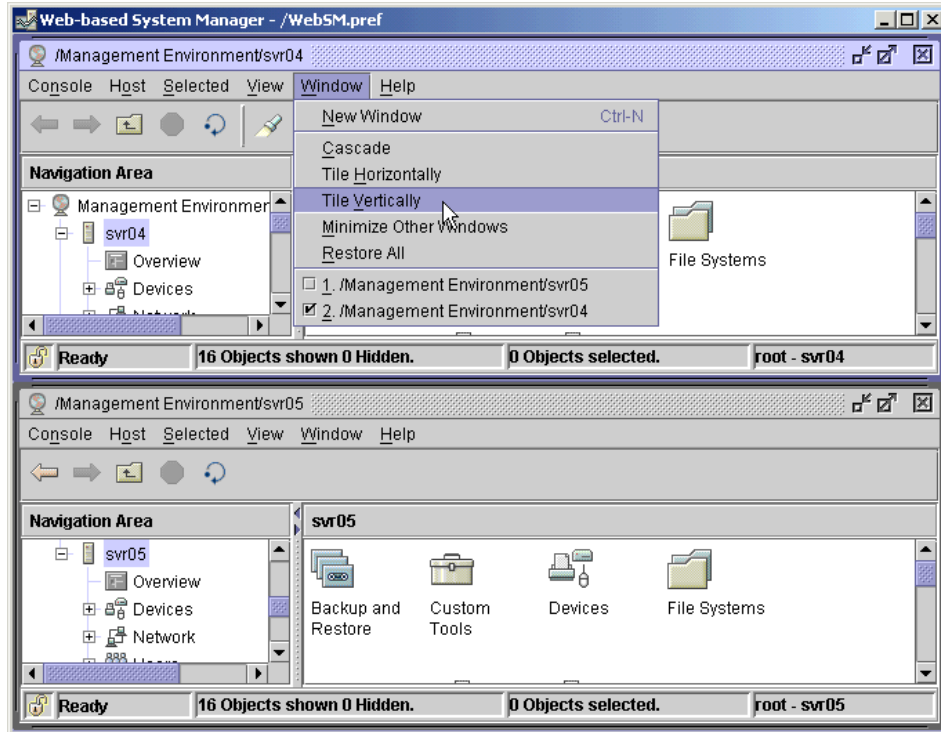

Figure 3-7 Tiled windows

3.2 RMC setup procedure

This section describes the general use and configuration of RMC from AIX 5L Version 5.1 Web-based System Manager for managing stand-alone servers.

Note: In AIX 5L Version 5.1, Web-based System Manager provides the functionality to configure stand-alone servers. If you are going to use RMC in a clustered environment, RMC should be configured and controlled using the command line interface.

3.2.1 Basic RMC concepts

Before you start using Web-based System Manager to configure and manage RMC, you should be familiar with several RMC terms explained in this section. Figure 3-8 on page 46 shows the Condition property dialog box and the terms shown in this dialog box are also explained in this section.

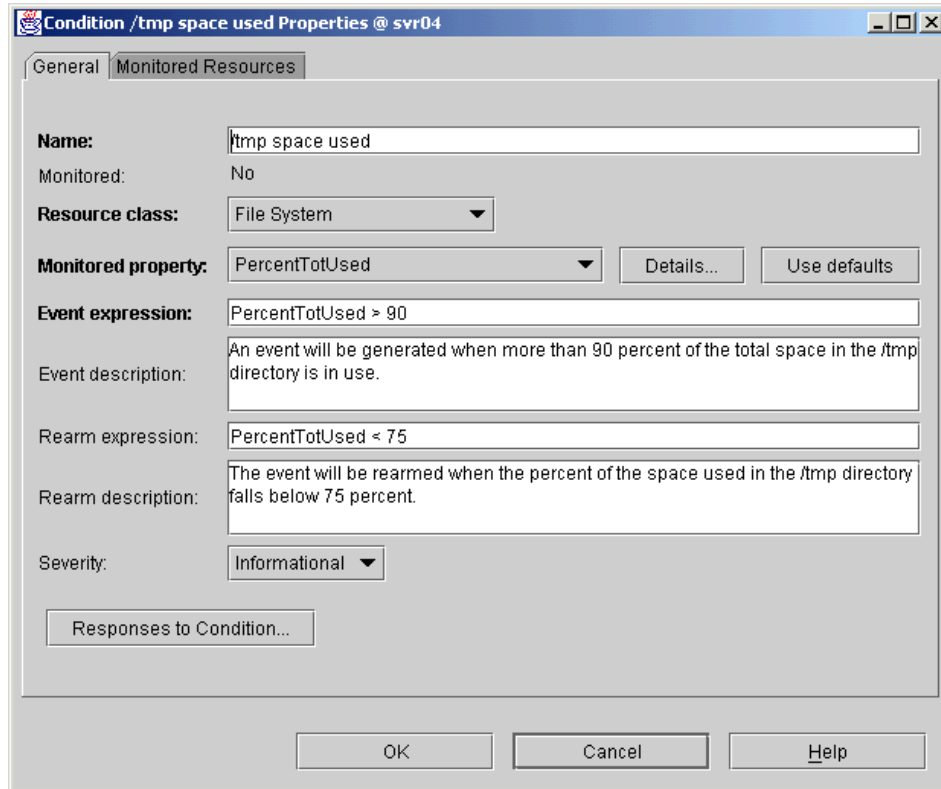

Figure 3-8 Condition properties dialog box

Name	A user specified unique identifier for a condition.
Resource class	Something that may be monitored (file system, Ethernet device, processor, and so on). You have to select the appropriate resource class from the pull-down selection list.
Monitored property	An attribute of the resource class. For the file system, an example attribute is PercentTotUsed, which is shown in the pull-down selection in Figure 3-8.
Event expression	An expression that determines when an event occurs. For example, the event expression “PercentTotUsed > 90” would cause an <i>event</i> if used storage on a file system became greater than 90 percent.
Event	When an event expression is evaluated to be true, an event is generated. At the time this occurs, RMC will

	execute responses associated with the event and RMC will consider the event to be in a current (true) state.
Rearm expression	An expression that determines when an rearm event occurs. For example the rearm expression “PercentTotUsed < 75” would cause a rearm event to occur if usage of a file system became less than 75 percent.
Rearm event	When a rearm event expression is evaluated to be true, a rearm event is generated only when the corresponding event has occurred already. At the time this occurs, RMC will execute responses associated with the rearm event and RMC will consider the rearm event to be in a current (true) state.
Condition	A named combination of properties including resource class, monitored property, event expression, and rearm expression. One of the predefined conditions is named “/tmp space used” and generates an event if /tmp is more than 90 percent used and a rearm event if /tmp is less than 75 percent used. The condition properties dialog box is shown in Figure 3-8 on page 46.
Response	This is a user defined predetermined course of action that takes place when an event occurs. A response can be single or multiple actions. Figure 3-12 on page 51 shows the standard predefined responses on AIX 5L Version 5.1.

Note: The “monitored property” field in this dialog box refers to what is called an *attribute* (explained in Section 2.2.3, “Attribute” on page 21). It is different from the term *property* used in (Section 2.2.3, “Attribute” on page 21). However, we use the term “monitored property” to refer this field throughout this chapter to be consistent with the terminology used in Web-based System Manager.

For further detailed explanation about terms used in RMC, see the following sections:

- ▶ Section 2.2, “Resource, resource class, and attribute” on page 19
- ▶ Section 2.4, “Expression” on page 30
- ▶ Section 2.5, “Condition, response, and action” on page 30

3.2.2 Step one: the Monitoring plug-in

For RMC, the first area of interest is the Monitoring plug-in. To open the plug-in, select Monitoring in the Navigation Area, as shown in Figure 3-9. To expand a sub-tree under the Monitoring icon, click the + symbol to the left of the icon. To collapse the sub-tree, click the - symbol.

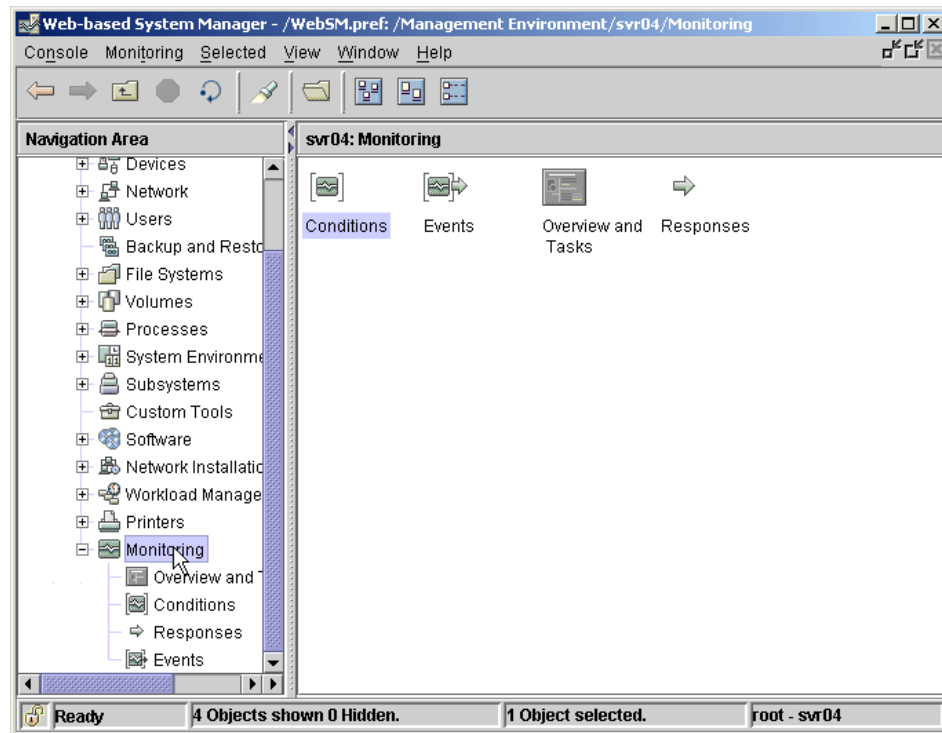

Figure 3-9 Selecting the Monitoring plug-in

3.2.3 Step two: the Conditions plug-in

If you want to see what conditions have been defined, you first need to open the Conditions plug-in, which shows all the predefined conditions provided by AIX 5L Version 5.1, by double-clicking the Conditions icon in the Monitoring pane, as shown in Figure 3-10 on page 49. You can also open this plug-in by clicking the Conditions icon in the Navigation Area.

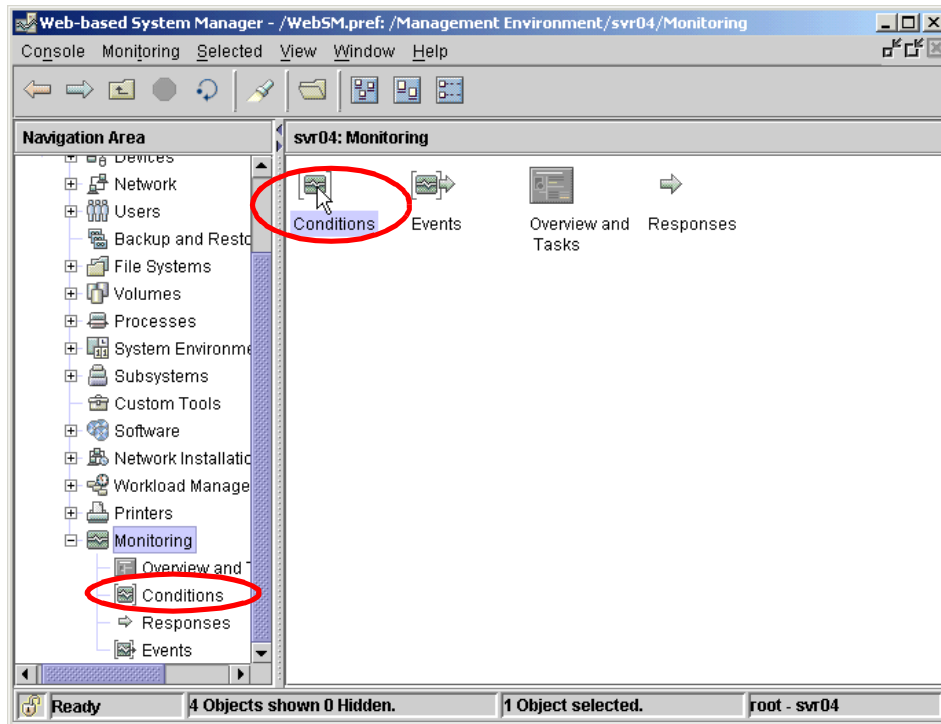

Figure 3-10 Selecting the Conditions plug-in

3.2.4 Monitoring a condition

When the Conditions plug-in is displayed, you are presented with all the conditions that Web-based System Manager can interact with. For example, if you wish to monitor the condition “tmp space used”, you can do this by right-clicking the icon labeled “/tmp space used”. You will see a pop-up menu, as shown in Figure 3-11 on page 50.

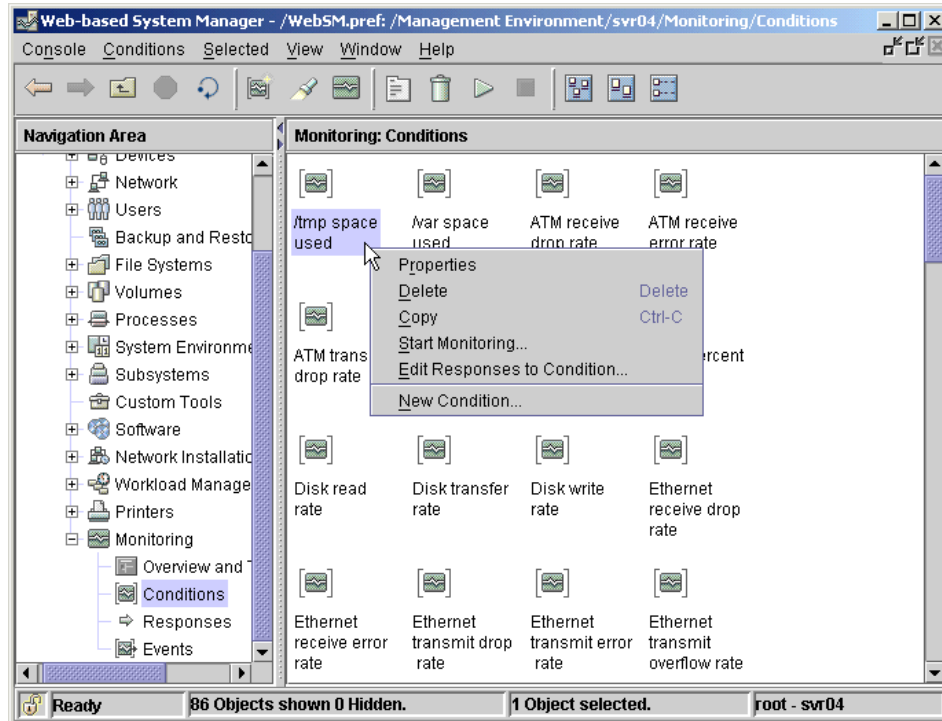

Figure 3-11 Conditions pop-up window

To start monitoring the condition, select **Start Monitoring...** You will be presented with the Edit Responses to Start Monitoring dialog box, as shown in Figure 3-12 on page 51.

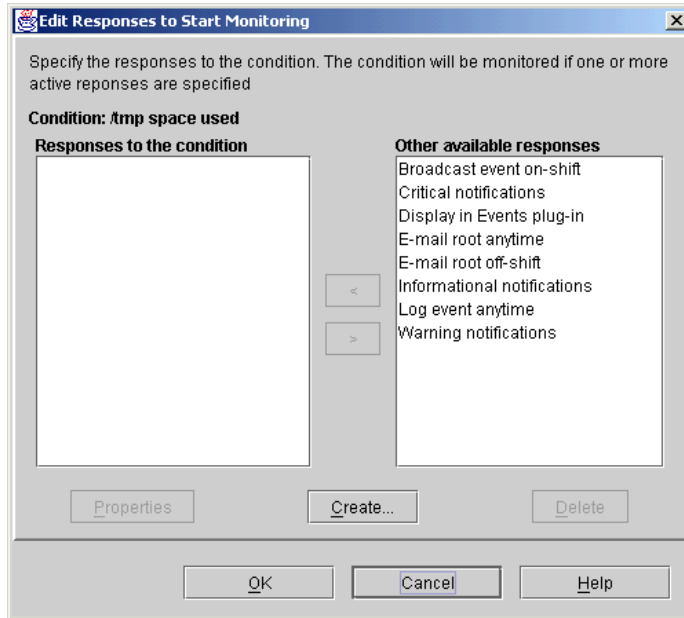

Figure 3-12 Edit responses dialog box (before selection)

Note: The “Other available responses” field in Figure 3-12 shows the predefined eight responses.

Condition monitoring cannot be started until the condition has at least one response associated with it. Figure 3-12 shows that this condition has no associated responses and gives a list of the available responses that can be associated with. To associate a condition with a response, select the desired response and click the < button.

Figure 3-13 on page 52 shows that the response “Broadcast event on-shift” is associated with the condition “/tmp space” and is checked as active. Click OK to start monitoring of this condition.

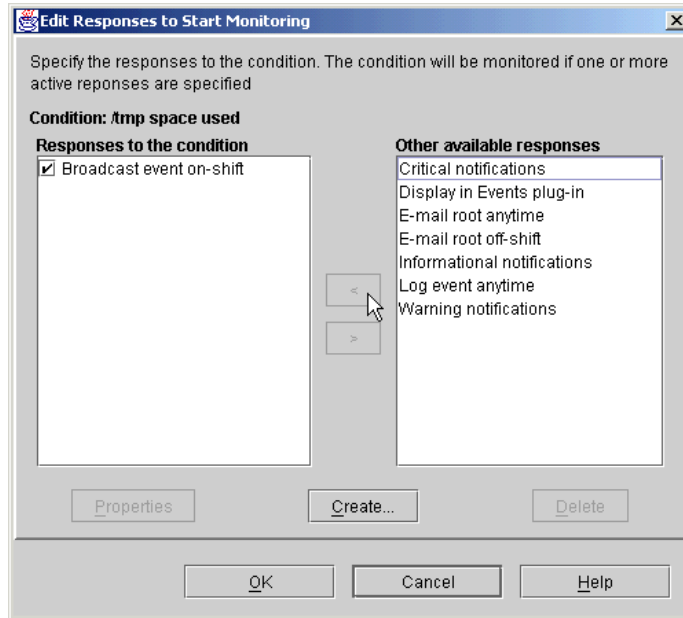

Figure 3-13 Edit responses dialog box (after selection)

Once monitoring of a condition has been started, Web-based System Manager will show you the message window shown in Figure 3-14 on page 53.

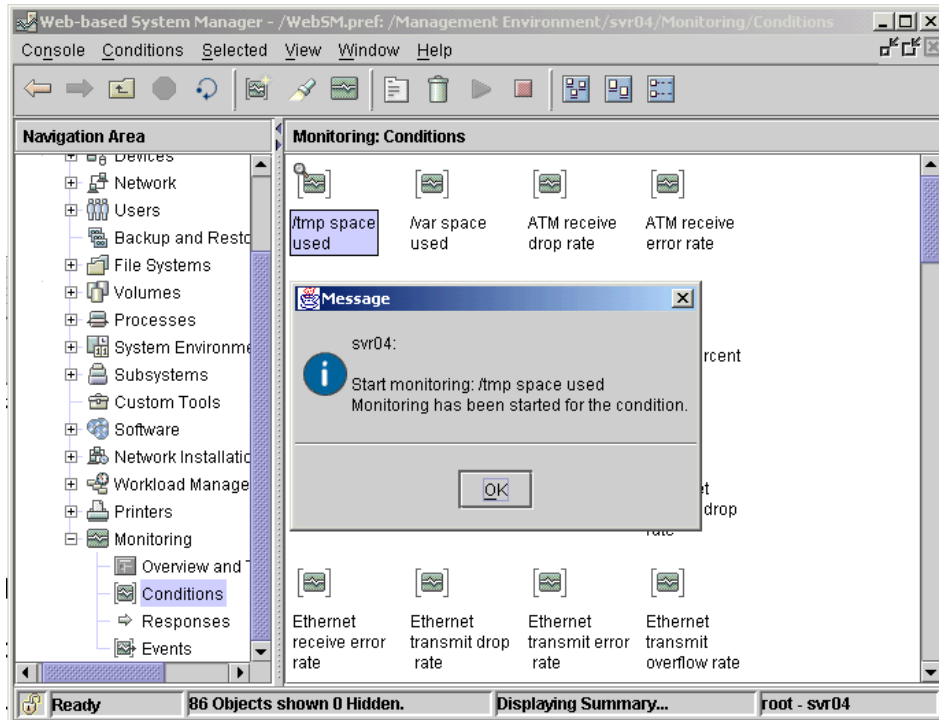

Figure 3-14 Monitoring started display

The system is now monitoring the condition “/tmp space used” and will perform the “Broadcast event on-shift” response when /tmp usage exceeds 90 percent and again when usage drops below 75 percent, this is described as an event and rearm event cycle.

To demonstrate the behavior, you can use the **yes** command to fill all the available space in /tmp, as shown in Example 3-1.

Example 3-1 Triggering /tmp space used, event and rearm

```
# df -k /tmp
Filesystem      1024-blocks    Free %Used    Iused %Iused Mounted on
/dev/hd3         32768         27356  17%         114    2% /tmp
# yes > /tmp/yes.log
```

Broadcast message from root@svr04.itsc.austin.ibm.com (tty) at 15:05:33 ...

Informational **Event** occurred for Condition /tmp on the resource /tmp of the resource class File System at Friday 06/07/02 15:05:32. The resource was monitored on svr04.itsc.austin.ibm.com and resided on {svr04.itsc.austin.ibm.com}.

```
^C
# rm /tmp/yes.log
# df -k /tmp
Filesystem      1024-blocks      Free %Used    Iused %Iused Mounted on
/dev/hd3         32768           27356   17%       114    2% /tmp
#

Broadcast message from root@svr04.itsc.austin.ibm.com (tty) at 15:07:33 ...

Informational Rearm event occurred for Condition /tmp space used on the
resource /tmp of the resource class File System at Friday 06/07/02 15:07:32.
The resource was monitored on svr04.itsc.austin.ibm.com and resided on
{svr04.itsc.austin.ibm.com}.
```

Note: Because this example uses the “Broadcast event on-shift” response, the only times it will work will be between 8 a.m. and 5 p.m. on Monday to Friday.

3.2.5 Viewing events

The response we associated with the “/tmp space used” condition in the previous example was to broadcast a message when the event and rearm event occurred, but this is not the only way of viewing event activity. For example, select the Monitoring view in Web-based System Manager, and then either right-click on the Events icon in the Navigation Area or double right-click on the Events icon in the Monitoring plug-in, as in Figure 3-15 on page 55.

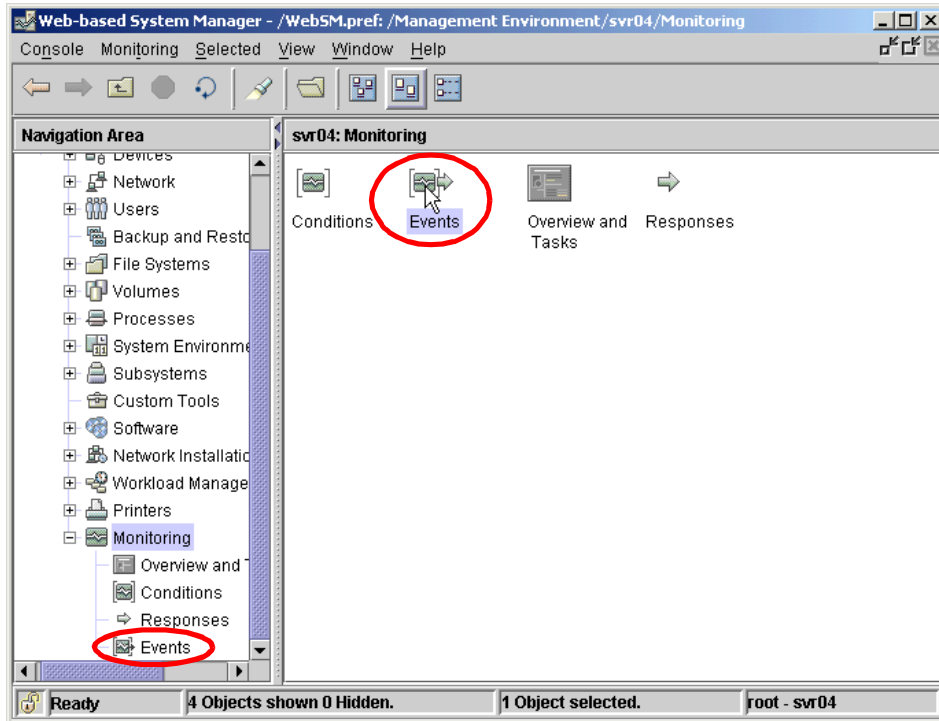

Figure 3-15 Selecting the Events plug-in

Note: You can view the events through the Events plug-in only; you cannot start or stop monitoring using it.

When the Events plug-in is selected, you have the option to view either all events that have occurred since this Web-based System Manager session was started or just the events that are *current* (an event has occurred, but no rearm event has yet occurred for that condition). Figure 3-16 on page 56 shows the Events plug-in (showing all events) displayed in conjunction with Example 3-1 on page 53.

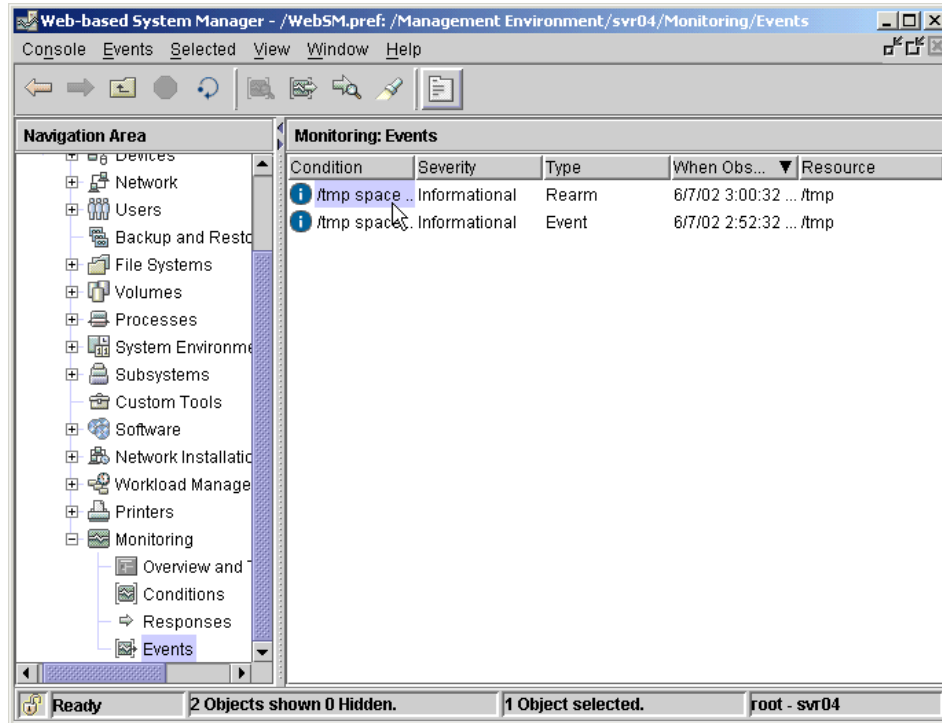

Figure 3-16 Events plug-in

To change which events are displayed (all or current), you can toggle the mode by clicking one of the following icons:

- Current Events



- All Events



If you require more information about any event shown in this window, double click the event you are interested in and you will be presented with the Event Properties dialog box, as shown in Figure 3-17 on page 57. It shows detailed information about the event and can be used to perform further investigation if required.

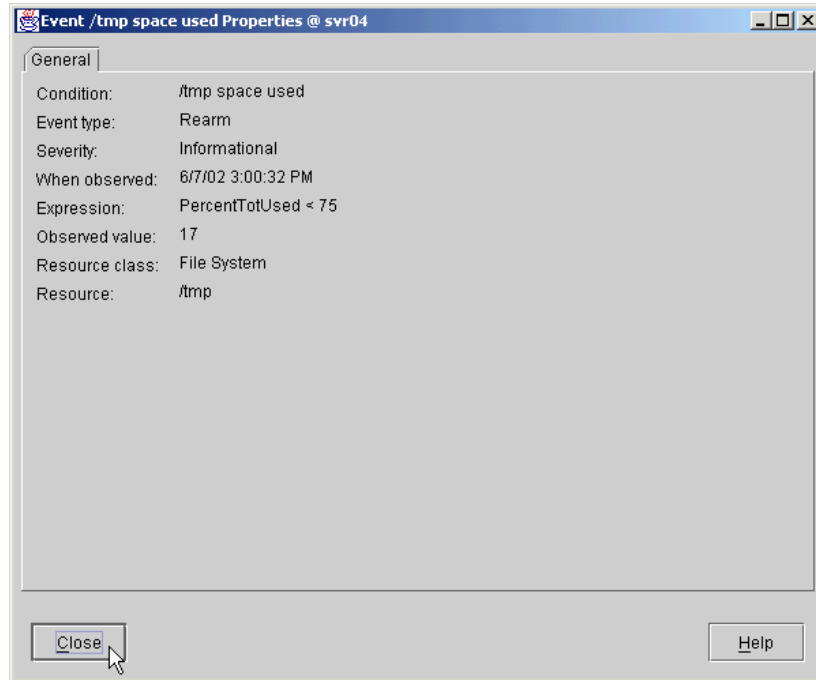

Figure 3-17 Event properties dialog box

3.3 Customizing your RMC configuration

Now you have RMC configured and running using the predefined conditions and responses in AIX 5L Version 5.1. You may need to configure your system to perform specific actions in response to specific circumstances. This section concentrates on how and what you can do with RMC to customize your system to your needs.

3.3.1 Properties of a condition

The condition is an important concept in RMC. A condition determines when an event or a rearm event occurs. The parameters of a condition can be viewed and modified in the Condition Properties dialog box. You can open this dialog box by either double-clicking or right-clicking and then selecting **Properties** on the icon of the condition you wish to examine, as shown in Figure 3-18 on page 58.

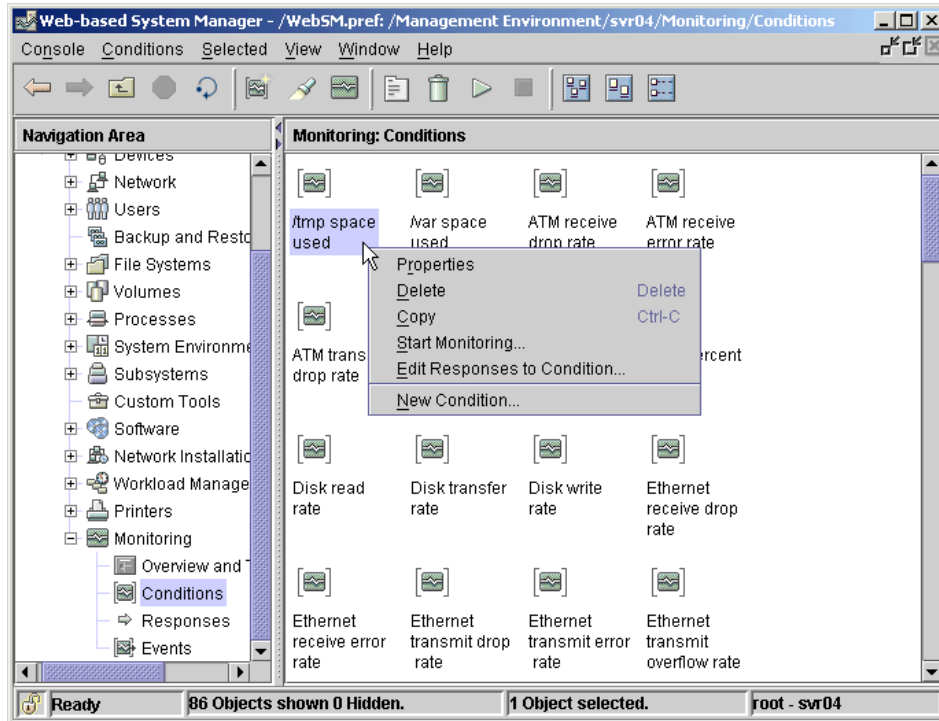

Figure 3-18 Displaying the properties of a condition

Condition properties

The Condition Properties dialog box shows the current properties associated with a condition. An example of the Condition Properties dialog box is shown in Figure 3-19 on page 59 and Figure 3-20 on page 60.

AIX 5L Version 5.1 provides a predefined set of conditions that may be used for monitoring system resources, and, if required, new conditions can be added or existing conditions may have their properties changed; these properties may be changed at any time.

3.3.2 Monitored resources

Conditions are configured to monitor resources on your AIX system and these resources are categorized into resource classes. In a resource class, there are multiple resources that can be monitored. For example, all the file systems in the system are represented as a resource in the file system resource class. This section shows how this characteristic may be used. To examine or change

properties of a condition, display the Conditions Properties dialog box, as explained in Section 3.3.1, “Properties of a condition” on page 57.

Figure 3-19 shows the Condition Properties dialog box for the “/tmp space used” condition. In this example, we are monitoring a resource in the file system resource class, as shown in the Resource class: field.

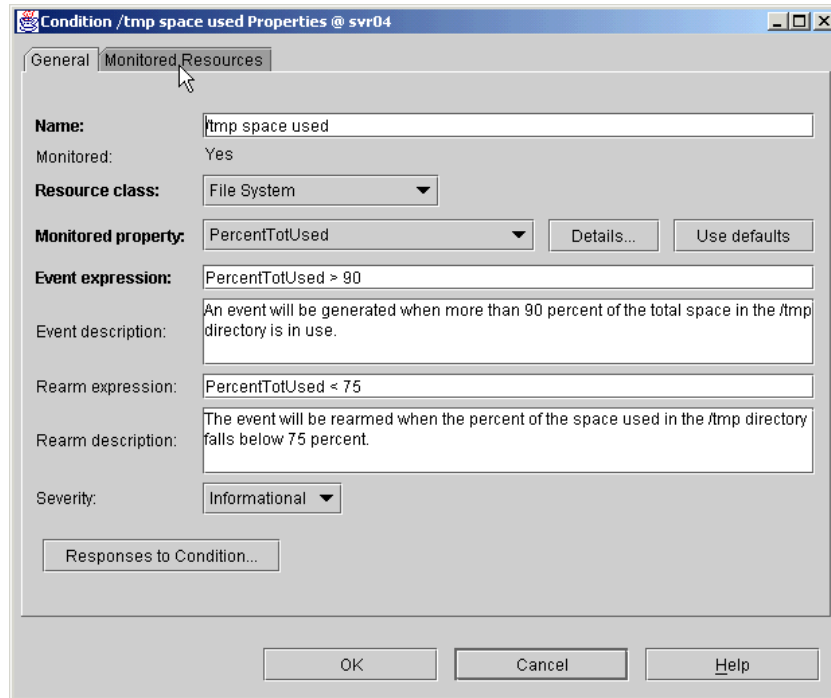

Figure 3-19 Condition Properties dialog box

Because there is more than one file system on the system besides /tmp, you have to specify that you are only interested in /tmp for this condition. This is shown in the Monitored Resources tab in the dialog box. To view or modify the monitored resources, click the Monitored Resources tab.

Figure 3-20 on page 60 shows the monitored resources page for this condition. The dialog box indicates that the predefined condition “/tmp used space” is monitoring /tmp only.

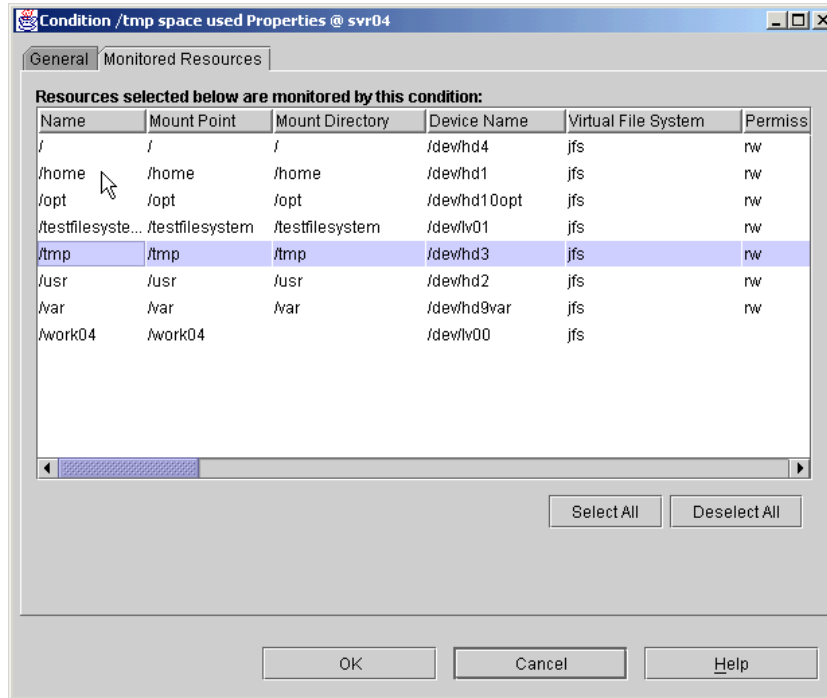

Figure 3-20 Condition Properties: Monitored Resources dialog box

If you need to change the monitored resources for a condition, you can use this page and select or add the new resource(s) to be monitored:

- ▶ To select a new resource to be monitored, select the resource you wish to monitor and the selection will be changed to the new resource, then click OK.
- ▶ To add or remove additional resource selections, hold the control key down and select the resource of which you want to add or remove. The selection is toggled by this action. Then click OK.
- ▶ To select a list of resources, select the first one and select the last while holding the shift key down. Then click OK.

Figure 3-21 on page 61 shows the selection of an additional resource (/home) to be monitored in the /tmp space used condition.

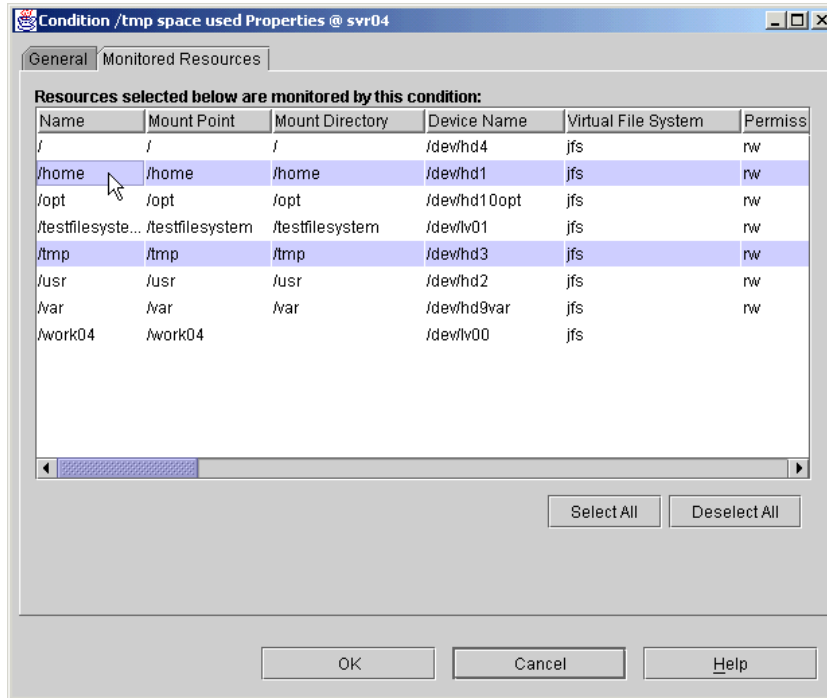

Figure 3-21 Selecting an additional resource

Now we have selected /home to be monitored in addition to /tmp. If either one of these file systems exceeds the 90 percent usage threshold, an event will occur, and the description of the event in the response in the audit log will show which resource caused the event to occur.

Note: You may want to define a new condition instead of modifying the predefined “/tmp space used” condition for this resource selection. See Section 3.4, “Creating a new condition or response” on page 70.

3.3.3 General Condition Properties

The Condition Properties dialog box defines the values that are used by RMC to monitor your system. If the AIX 5L Version 5.1 predefined conditions do not match your requirements, you can use the condition properties dialog box to tune the system behavior.

Figure 3-22 on page 62 shows the Condition Properties dialog box for the “/tmp space used” condition. In this example, the rearm expression is being modified

so that the rearm event occurs when the PercentTotUsed value is less than 80 percent, as shown in the highlighted field.

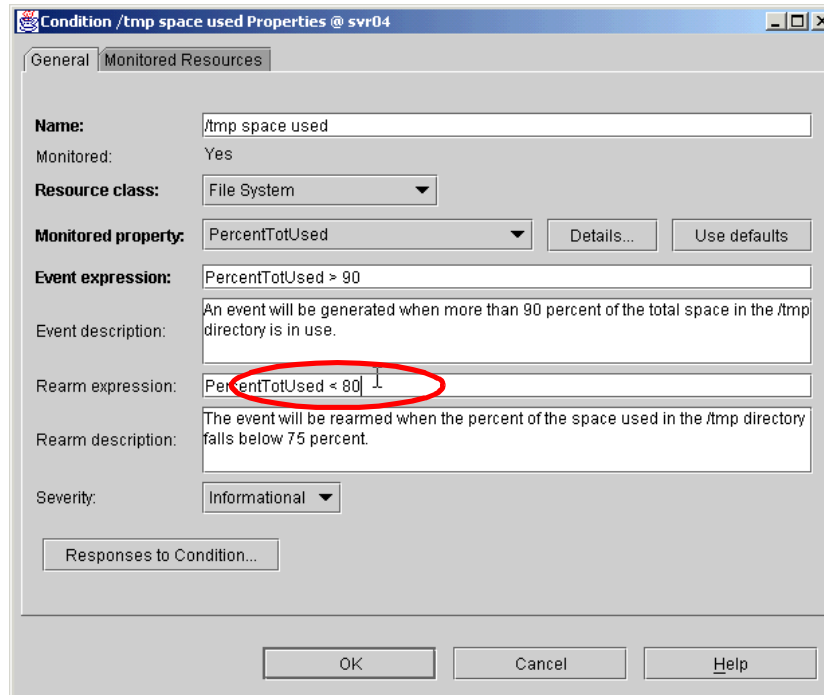

Figure 3-22 Condition Properties dialog box: changing the rearm expression

In the Condition Properties dialog box, you can select a monitored property from several properties defined by the resource class. For the file system resource class, there are the following four properties that can be monitored:

- ▶ ConfigChanged
- ▶ OpState
- ▶ PercentInodeUsed
- ▶ PercentTotUsed

To change the monitored property, click the Monitored property: field. You will see the drop-down menu shown in Figure 3-23 on page 63.

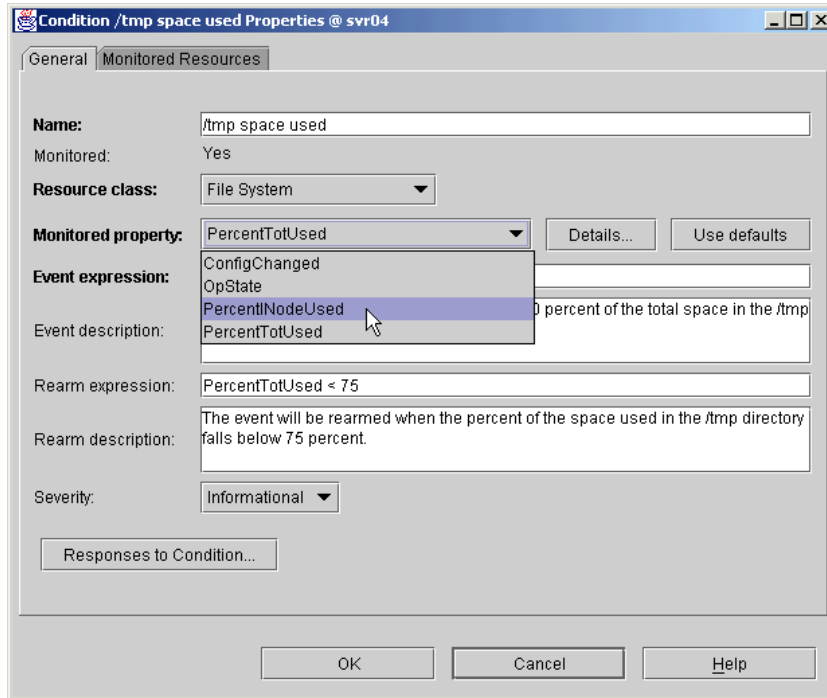

Figure 3-23 Condition Properties dialog box: changing the monitored property

3.3.4 Responses to a condition

Before configuring RMC, it is important to understand the relationship between conditions and responses. A condition includes the following information:

- ▶ Resource(s) to be monitored
- ▶ An event expression
- ▶ A rearm event expression (optional)

Then the condition can be associated with one or more responses. AIX 5L Version 5.1 provides a set of predefined responses and these can be associated with any conditions, including the predefined conditions.

You can change the association between a condition and responses by clicking the Responses to Condition... button in the Condition Properties panel, as shown in Figure 3-24 on page 64.

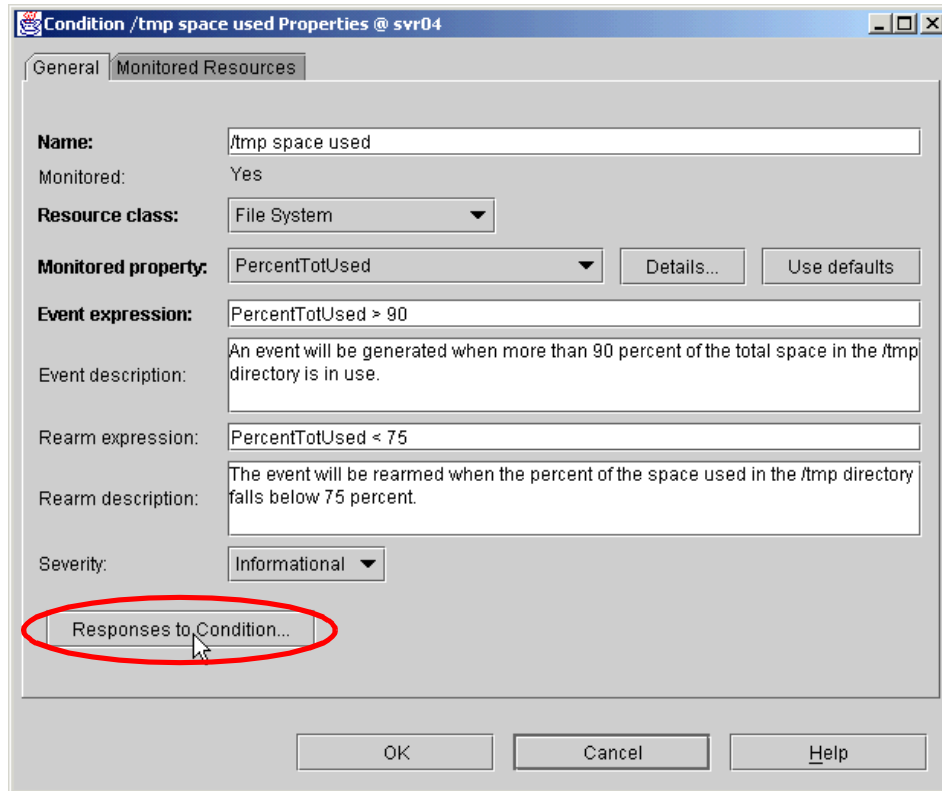

Figure 3-24 Condition Properties: Responses to Condition button

Figure 3-25 on page 65 shows the Edit Response to Condition dialog box. There are two responses, "Broadcast event on-shift" and "Critical notifications", associated with the condition. You can also see other predefined responses in the "Other available responses" field.

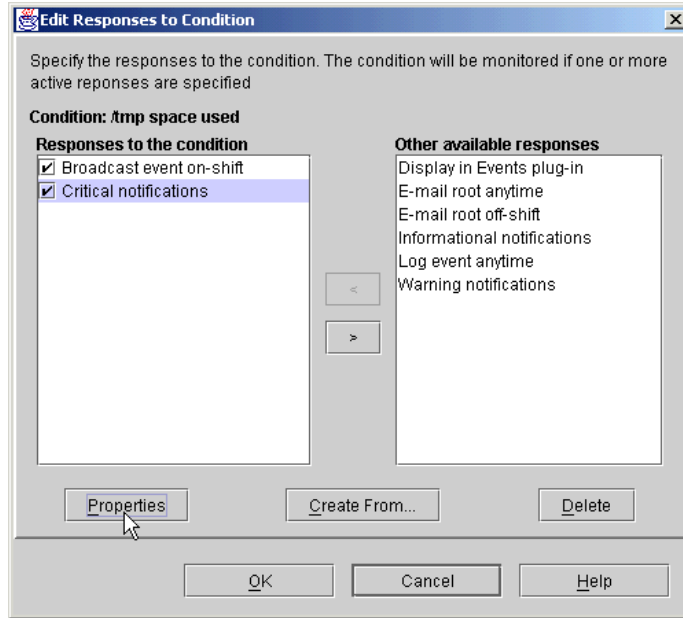

Figure 3-25 Edit Responses to Condition

To see the detailed information about a response, select the response in the panel, then click the Properties button.

Figure 3-26 on page 66 shows the properties dialog box of the “Critical notifications” response. In this example, the “Critical notifications” response comprises the following three actions:

- ▶ Log critical event
- ▶ E-mail root
- ▶ Broadcast message

The properties of the response are displayed in the Response Properties dialog box and this shows what *actions* are taken by the response. A response can have one or more actions and each action can perform a different task.

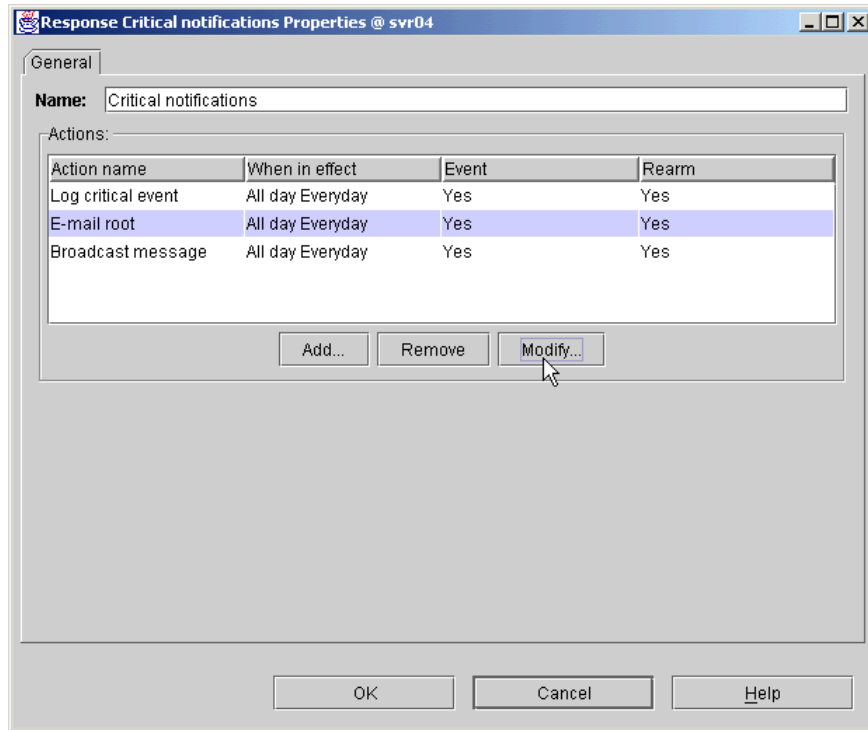

Figure 3-26 Response Properties dialog box

To see the detailed information about an action, select the action in the dialog box, then click the Modify... button.

Figure 3-27 on page 67 shows the detailed information of the “E-mail root” action.

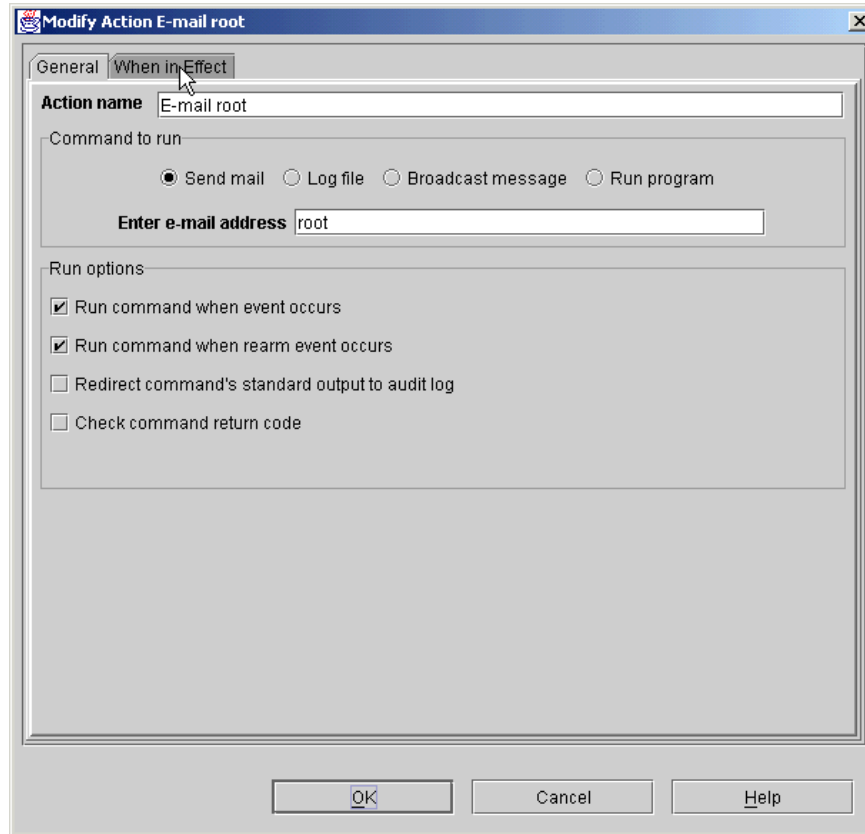

Figure 3-27 Modify Actions dialog box

The Modify Actions dialog box shows the name of the action and the parameters of the action. An action can have only one command defined, as shown in the “Command to run” field in the dialog box. These commands are executed when the associated event (or rearm event) occurs. The following list explains how these commands work to send information about the occurred event (or rearm):

- Send mail** Sends an e-mail to the specified e-mail address.
- Log File** Adds an entry into the specified log file.
- Broadcast message** Broadcasts a message to all the users who are logging in using the **wallevent** command.
- Run Program** Executes a user specified program.¹⁴

¹⁴ You can write your program (script) using your favorite language such as Korn shell and Perl.

If you select Run Program, then the specified program is invoked with a set of environment variables set by RMC.

Actions can be specified to run at certain times of the day or days of the week. Thus, RMC can be configured to perform different actions for events occurring during normal work hours or occurring overnight. Click the “When in Effect” tab to display the time settings of the action, as shown in Figure 3-28.

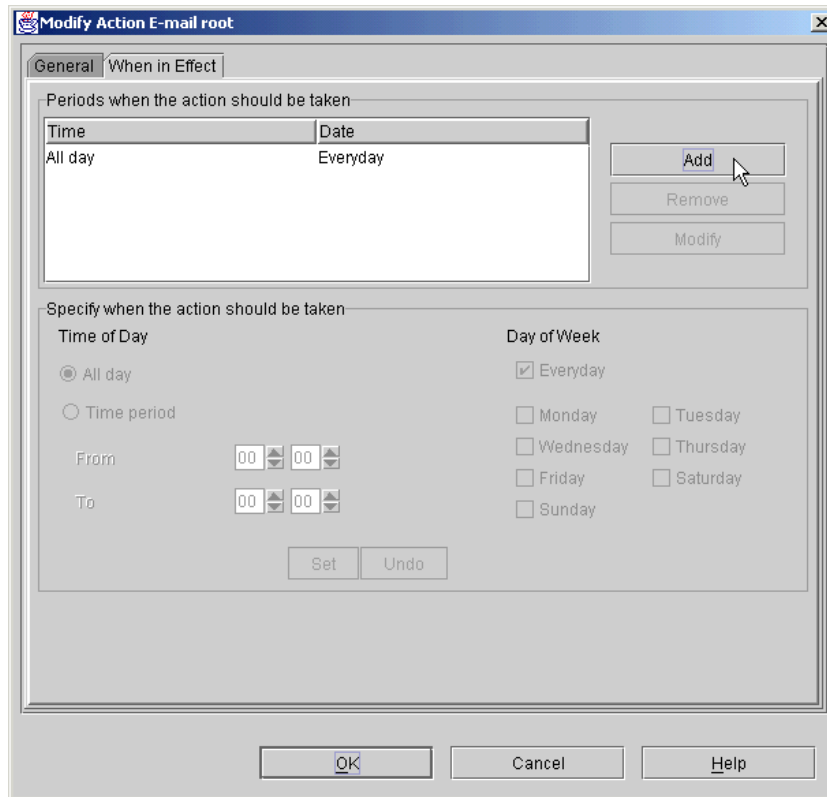

Figure 3-28 Modify Action: When in Effect

If you click the Add button, then the Time of Day and the Day of Week radio buttons will become selectable, as shown in Figure 3-29 on page 69.

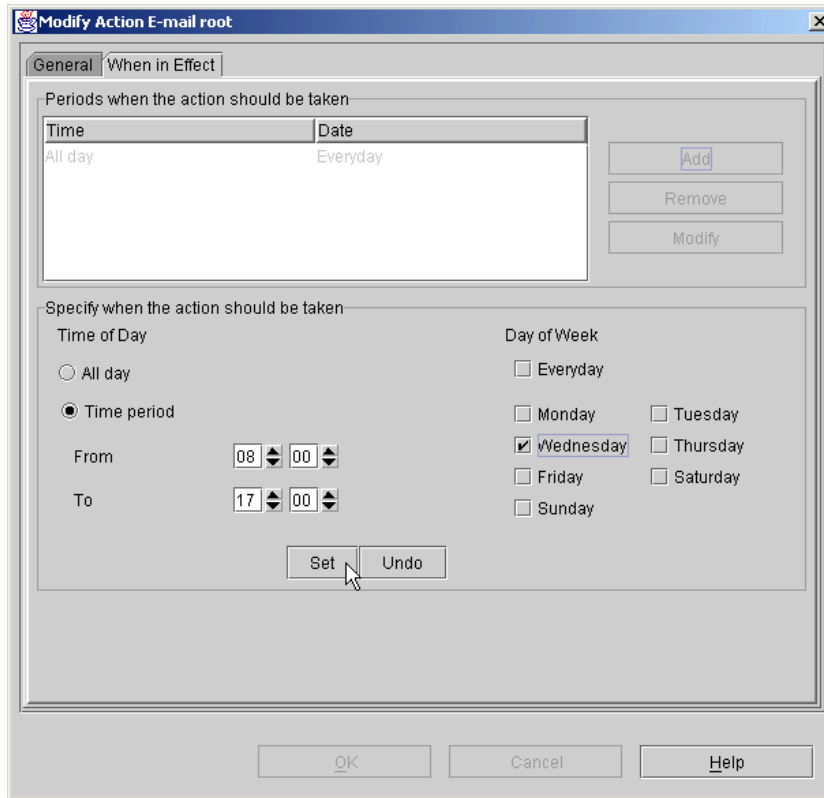

Figure 3-29 Modify action: setting the new period

To add a new period, select the time of day and day (or days) of the week. When you have completed your selection, click the Set button and your new selection will appear, as shown in Figure 3-30 on page 70.

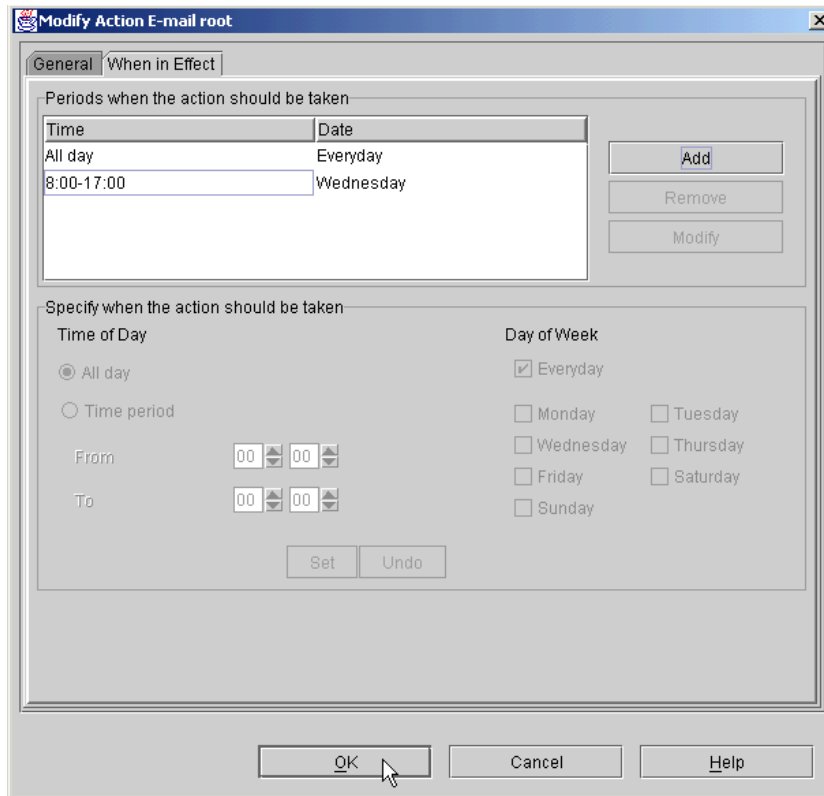

Figure 3-30 Modify action: new period addition complete

The new time period is specified, and to make the selection take effect, click OK. If you wish to cancel the modifications, click Cancel; all changes will be removed.

If there is time period besides “All day”, you can remove or modify the selected time period by clicking the Remove or Modify buttons.

3.4 Creating a new condition or response

You can easily create a new condition or response, though AIX 5L Version 5.1 provides many conditions and responses by default. The customized condition and response may fit into your specific monitoring requirement. This section steps through the procedures on how to create a new condition or response.

3.4.1 Creating a new condition

Web-based System Manager provides you with several ways to create a new condition. For example, you can select the “Create a new condition” task in the the Overview and Tasks plug-in, as shown in Figure 3-31.

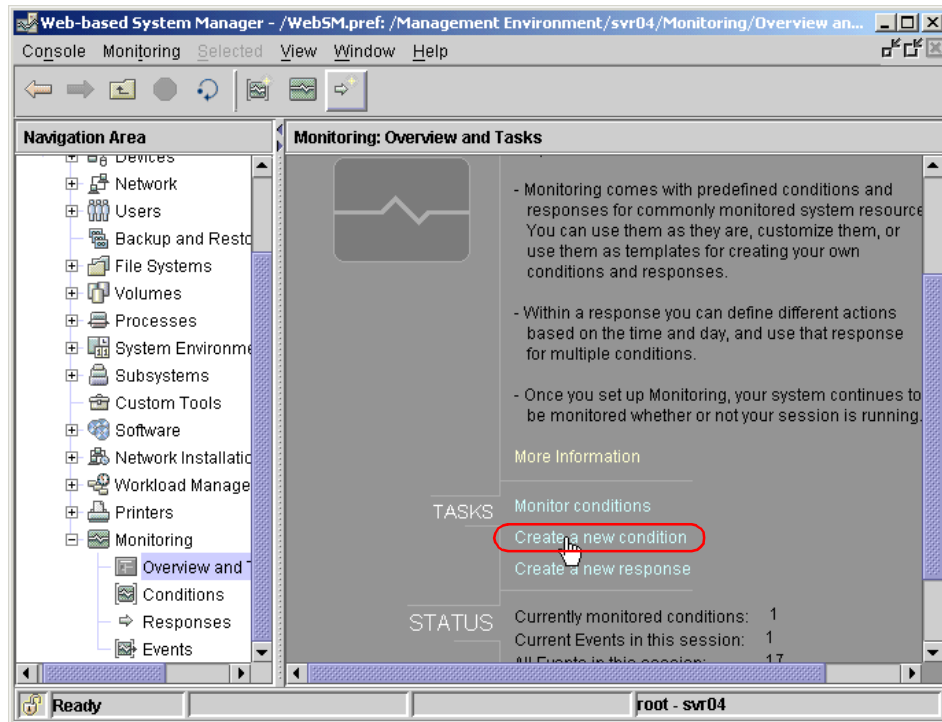

Figure 3-31 Creating a new condition from the Overview and Tasks plug-in

You can also create a new condition by clicking the following icon:



Both methods will pop up the New Condition dialog box as shown in Figure 3-32 on page 72. The dialog box allows you to define the properties of the new condition. For example, you can define a condition that monitors the state of a file system and associate it with a response that mounts the file system automatically if RMC detects that the file system is unmounted.

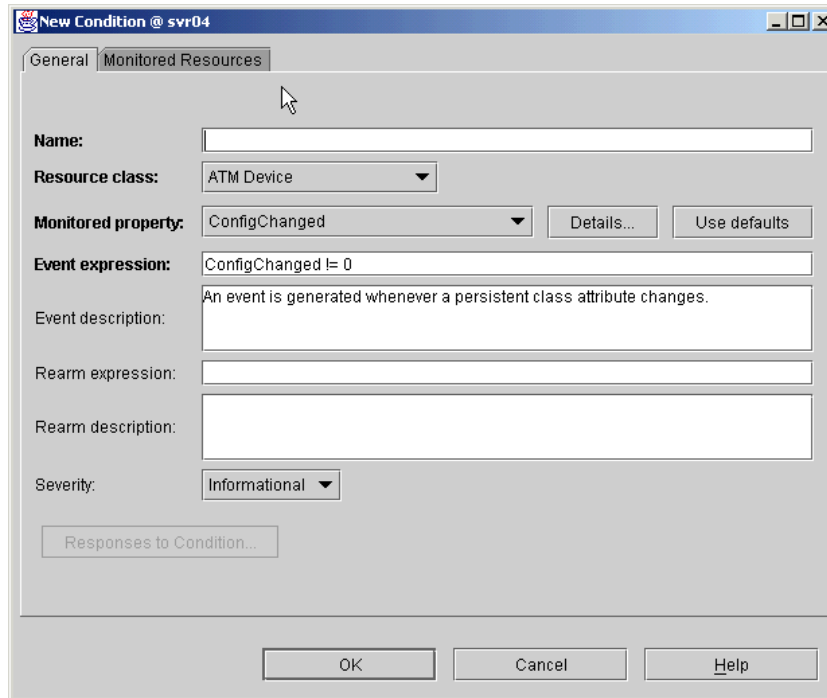

Figure 3-32 New Condition dialog box

To create a new condition, do the following in the dialog box:

1. Select the appropriate resource class from the pull-down menu in the “Resource class” field. In Figure 3-32, we selected the File System resource class.
2. Specify a condition name in the Name: field. This condition name must be unique in the system and self-descriptive to explain the purpose of the condition. In Figure 3-32, we specified “Check /work04” as the condition name.

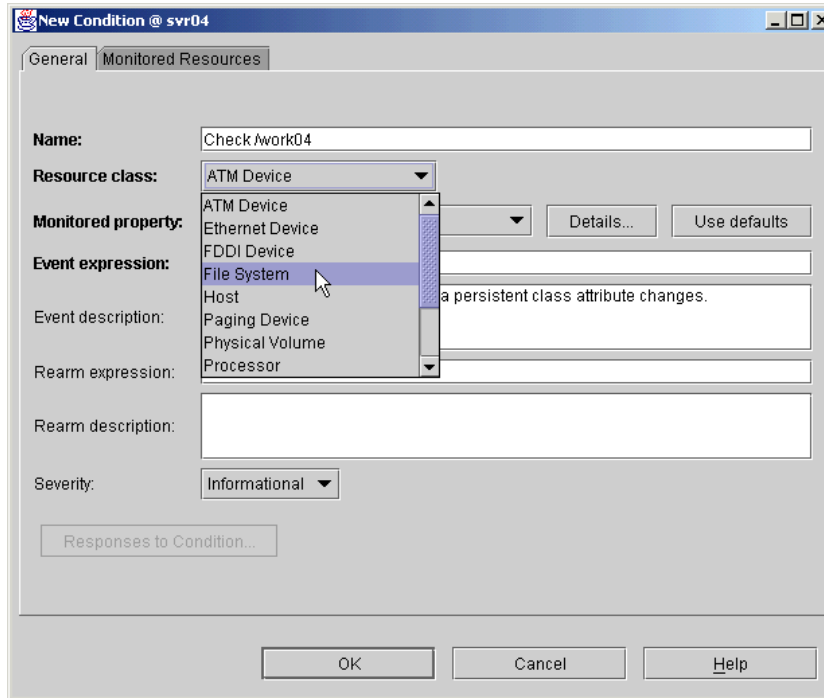

Figure 3-33 New condition: file system resource class

3. Select the Monitored Resources tab to select the resource to be monitored by this condition, as shown in Figure 3-34 on page 74.

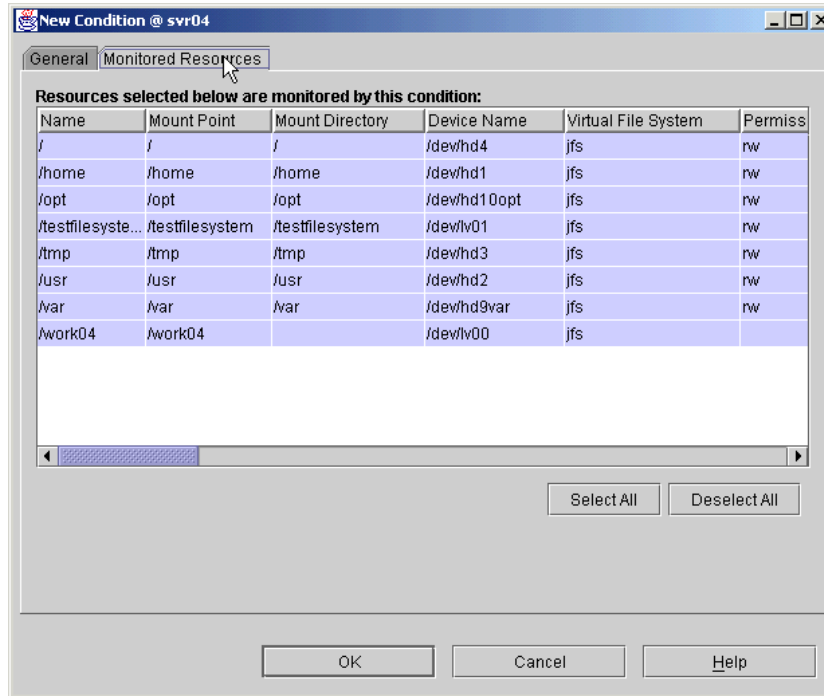

Figure 3-34 New condition: monitored resources, all file systems

In this example, we only selected the /work04 file system, as shown in Figure 3-35 on page 75.

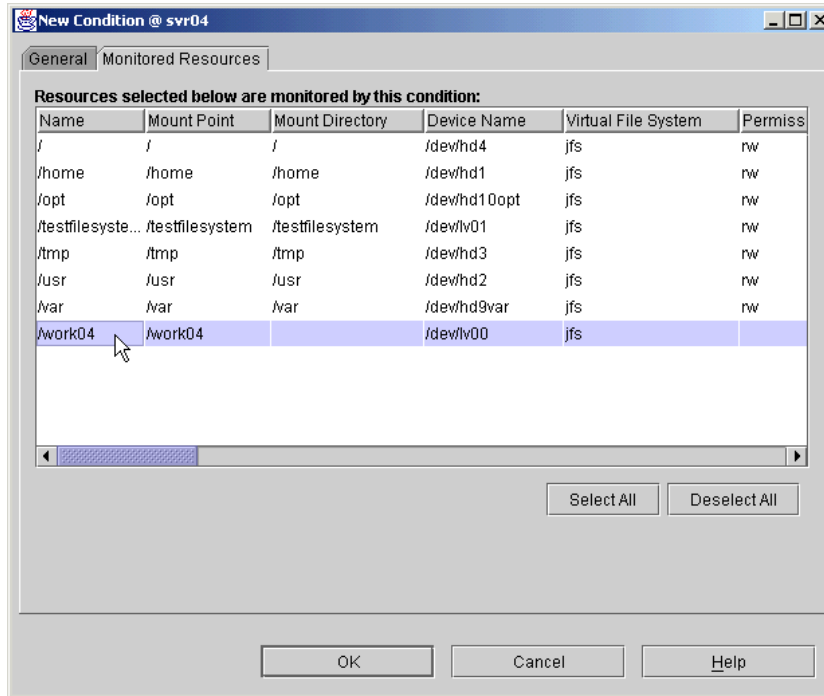

Figure 3-35 New condition: /work04 file system selected

- Once you have selected the resource class, then you can select monitored property from the pull-down menu in the Monitored Property: field. In Figure 3-36 on page 76, we selected the OpState property. The OpState property is used to check if the specified resource is available.

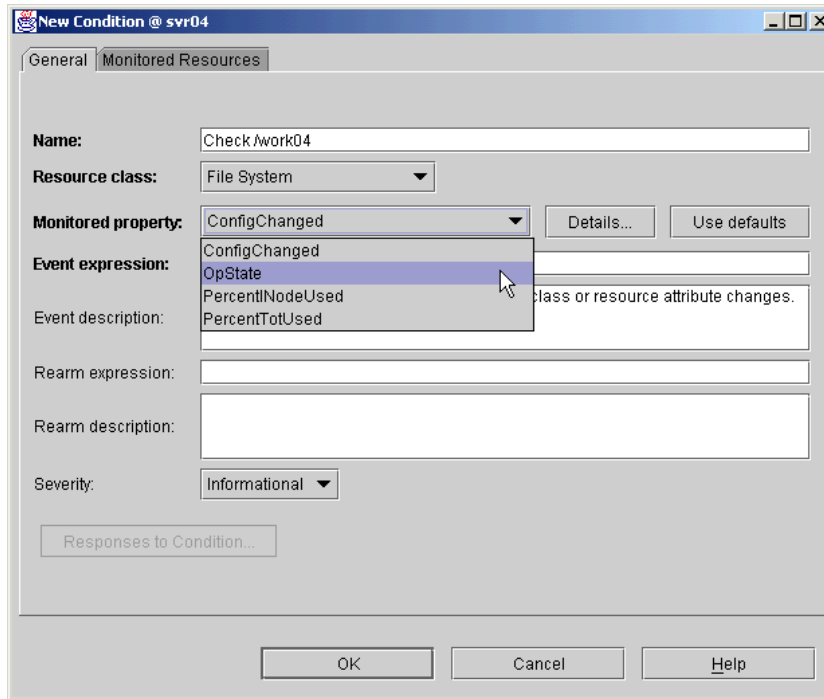

Figure 3-36 New condition: OpState monitored property

- Then specify the rest of fields in the panel, as shown in Figure 3-37 on page 77. In this example, we typed the values shown in Table 3-1.

Event expressions are used to determine if an event or rearm event should be generated for conditions that are monitored. The event expression `OpState != 1` means that an event will be generated for the “Check /work04” condition if RMC detects the resource (the /work04 file system) is unavailable (unmounted). The rearm expression `OpState == 1` means that a rearm will be generated for the “Check /work04” condition if RMC detects that the resource (the /work04 file system) is available again (mounted).

Table 3-1 Values for the new condition

Field name	Value
Event expression	<code>OpState != 1</code>
Event description	The file system has become unavailable
Rearm expression	<code>OpState == 1</code>
Rearm description	The file system has become available again

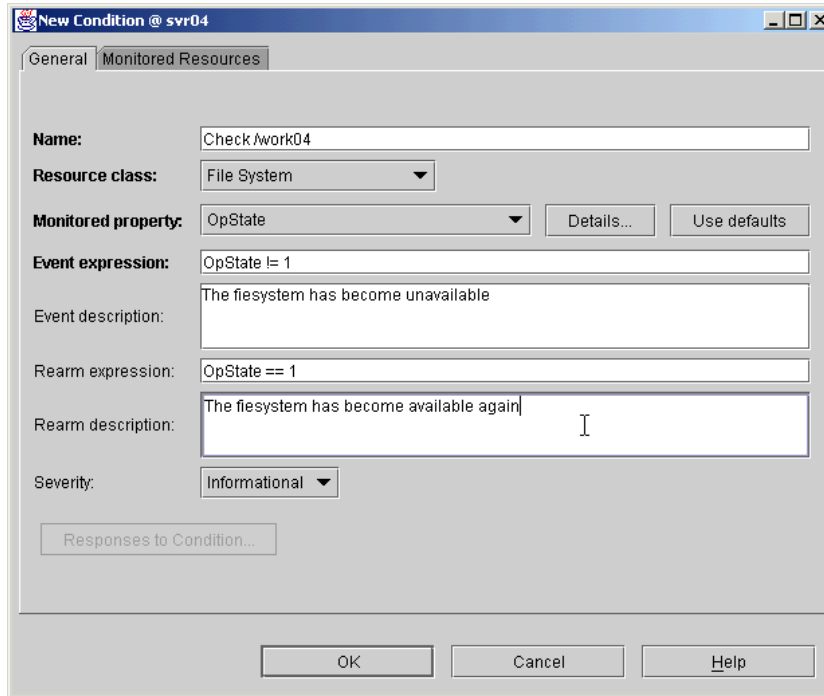

Figure 3-37 New condition, expressions completed

6. Select the severity level by selecting the pull-down menu in the Severity: field, as shown in Figure 3-38 on page 78. The severity level indicates the relative importance compared to other conditions. Then click OK.

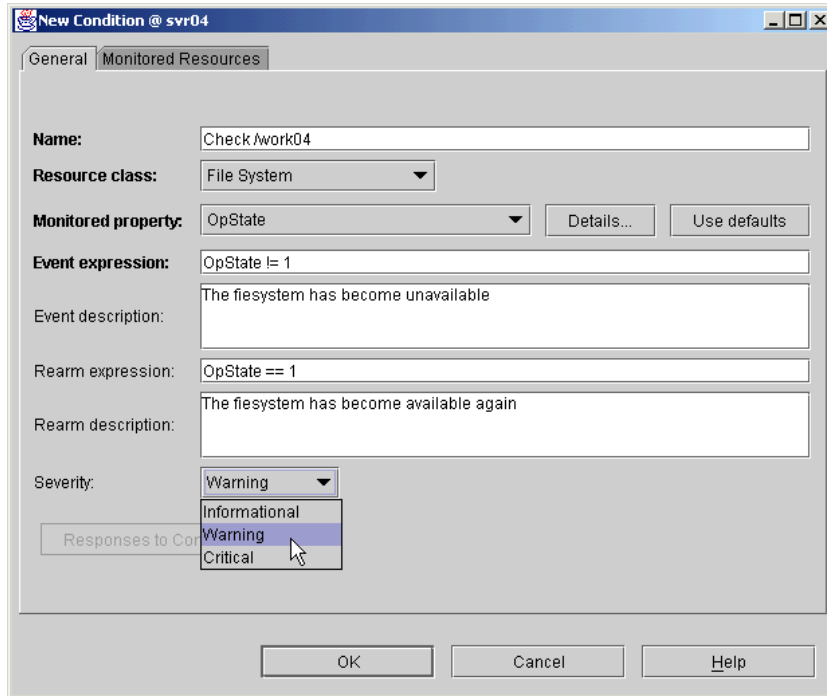

Figure 3-38 New condition: severity definition

7. Finally, you will see that the new condition icon “/work04 Checked” will be placed in the Monitoring: Conditions plug-in, as shown in Figure 3-39 on page 79.

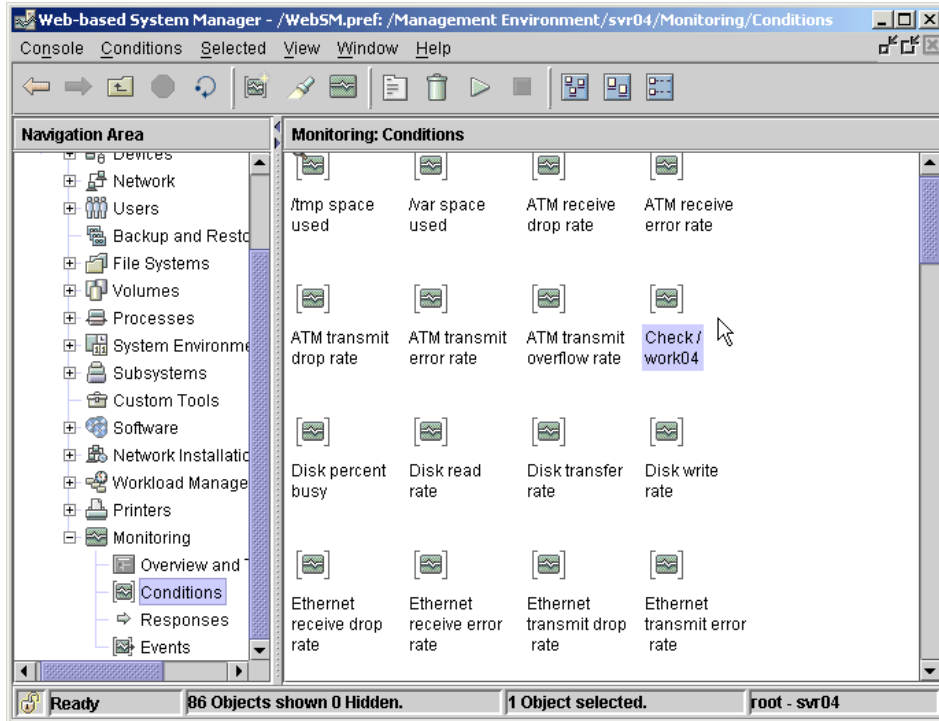

Figure 3-39 New condition created

If you select the events plug-in by selecting the following Events tree, the Events plug-in shows events that have occurred on the monitored system and indicate the severity of the event, as designated in the condition properties dialog box:

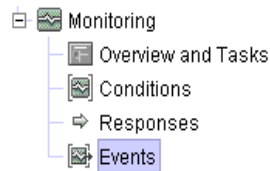

Figure 3-40 on page 80 displays with All Events selected to show all the events that have occurred during this session. To change the display mode, select the appropriate icon (current and all), as explained in Section 3.2.5, “Viewing events” on page 54.

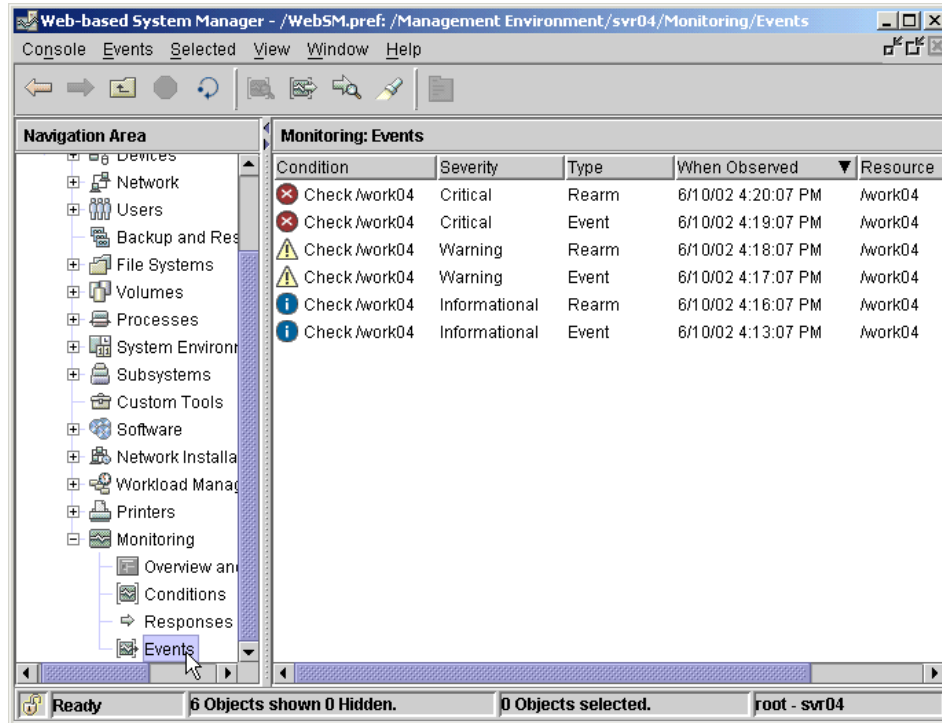

Figure 3-40 Events panel showing different severity events

3.4.2 Creating a new response

To start monitoring a condition, it must have at least one response associated with it. This section steps through this procedure and shows how actions and responses can be created and customized to a specific requirement.

To configure the responses of a condition, do the following:

1. Display the Conditions plug-in and right-click the condition you wish to modify, as shown in Figure 3-41 on page 81, and then select **Edit Responses to Condition...**

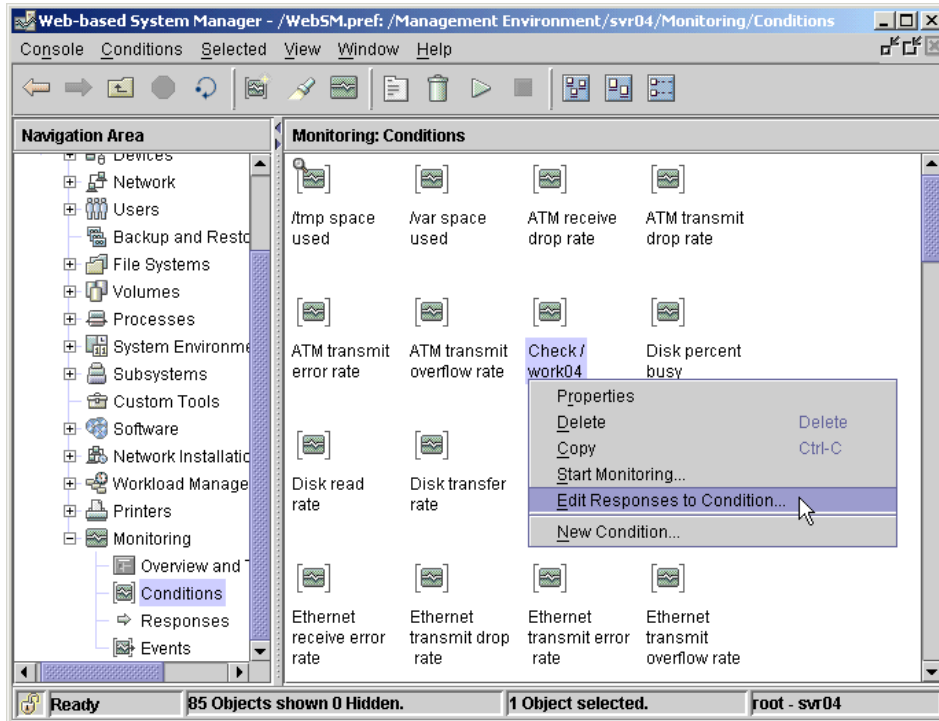

Figure 3-41 New response: drop-down menu

2. You will see the Edit Response to Condition dialog box, as shown in Figure 3-42 on page 82.

In this dialog box, you can do the following tasks:

- Associate the available responses, including predefined ones, with the condition.
- Create your own response and associate it with the condition.
- Modify the association between the condition and the responses.
- Delete the responses that you do not need any more.

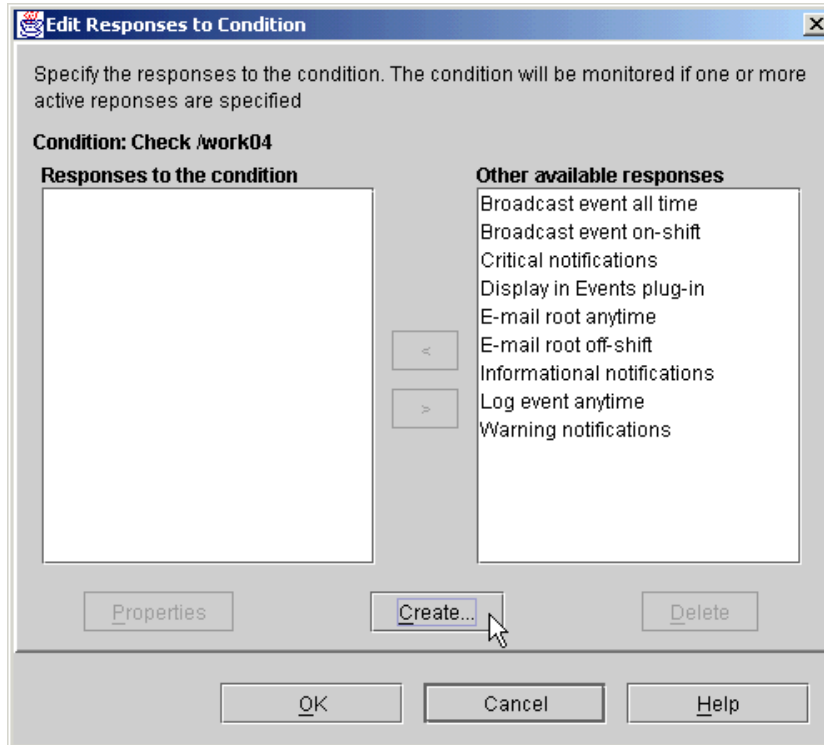

Figure 3-42 Edit Response: create a response button

In this example, we are going to create a new response, because there is no predefined response that operates file system related tasks. To create a new response, click the Create... button.

3. You will see the New Response dialog box, as shown in Figure 3-43 on page 83.

You have to specify the unique name in the Name: field first. In this example, we specified "Attempt remount". Then click the Add... button to define a new action.

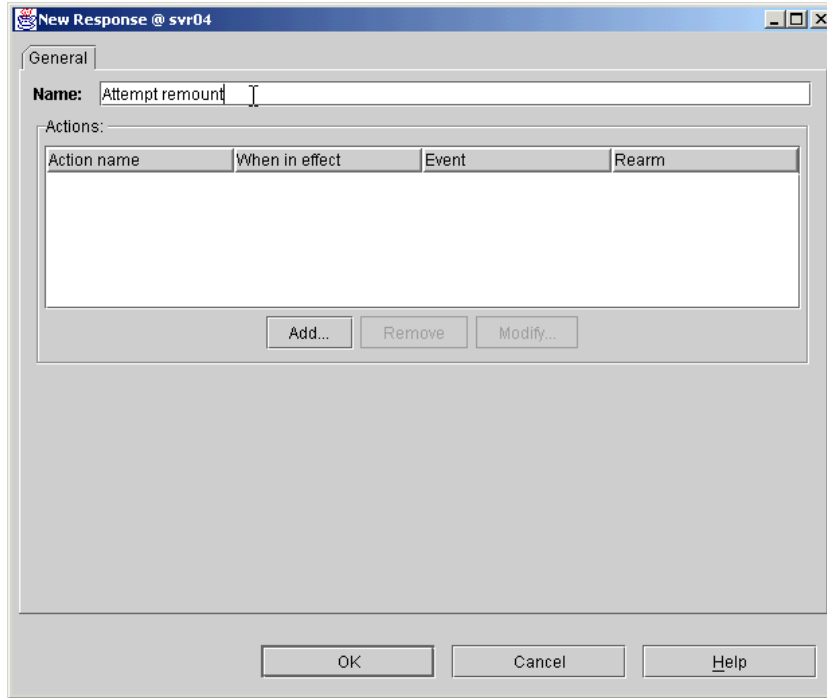

Figure 3-43 New Response dialog box: specifying the name of the response

4. You will see the Add Action panel.

In this example, we provided an action name and selected “Run program” in the command to run field in Figure 3-44 on page 84. The string specified in the “Enter program name” field, /home/remount, is the shell script path name to be executed as an action if the response is triggered.

For further information how to use this dialog box, see Figure 3-27 on page 67. See Example 3-2 on page 90 for an example of the /home/remount script.

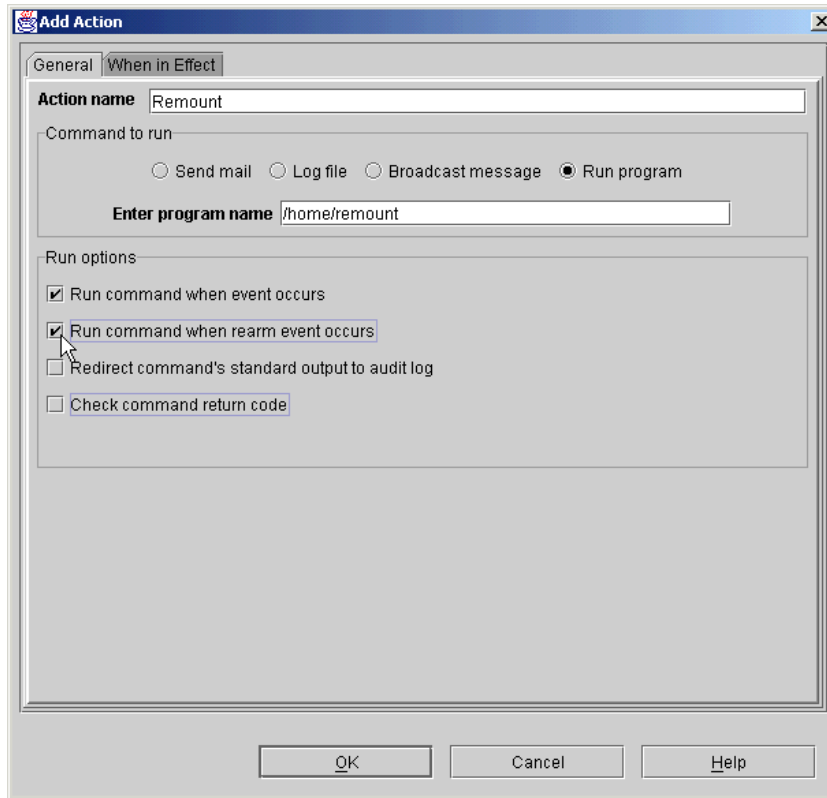

Figure 3-44 Add Action dialog box

5. You have to specify when the action is actually in effect by clicking the When in Effect tab in the Add Action dialog box, as shown in Figure 3-45 on page 85.

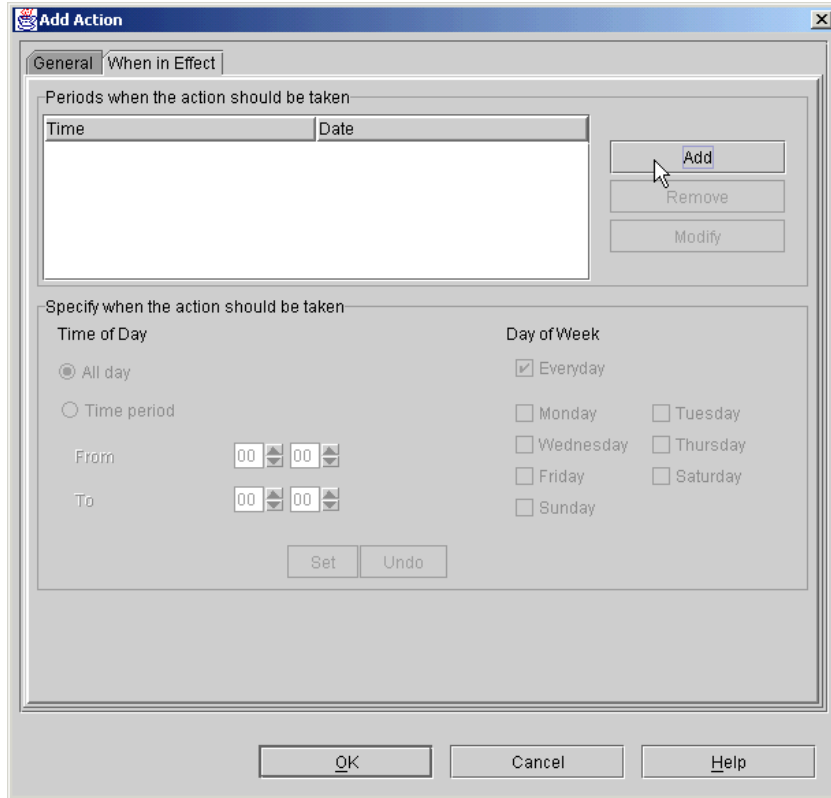

Figure 3-45 New response: When in Effect tab

By default, there is no time period defined. If you click OK without specifying any time period, you will see a warning panel, as shown in Figure 3-46.

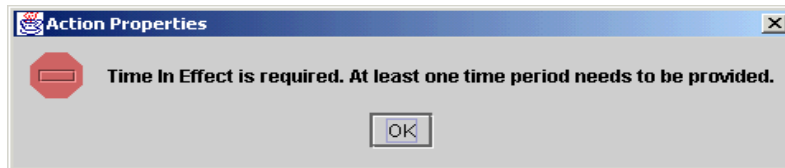

Figure 3-46 Time in Effect is required

6. If you click Add, then the Time of Day and the Day of Week radio buttons will become selectable and the All day Everyday period will be shown, as shown in Figure 3-47 on page 86.

In this example, we simply click Set to specify the All day Everyday time period. Then click OK, and this action will return you to the Edit Response to Condition dialog box, as shown in Figure 3-48 on page 87.

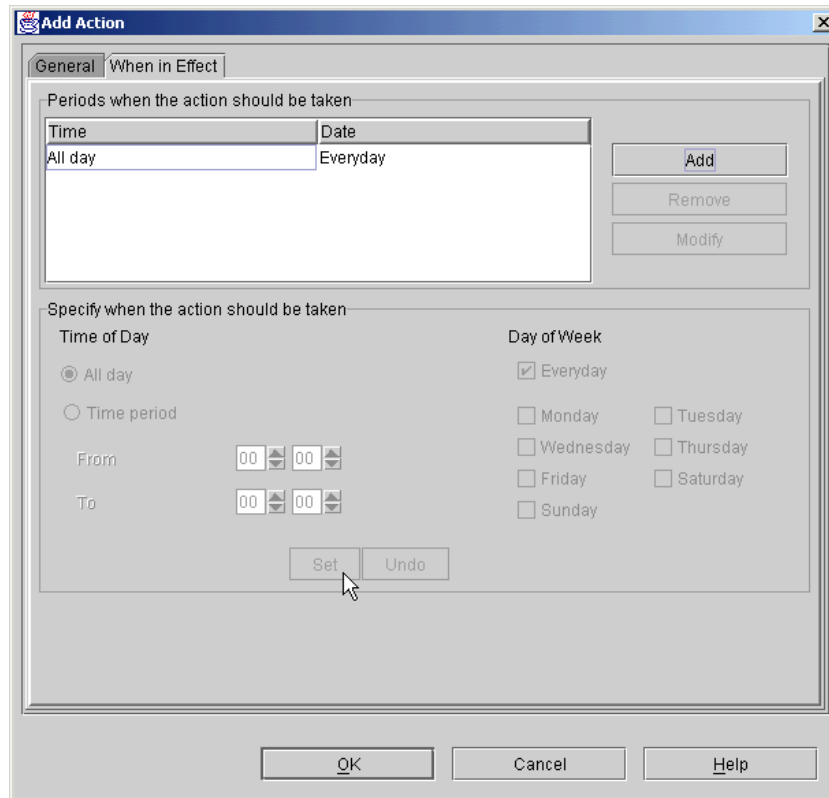

Figure 3-47 New response: When in Effect page period defined

7. The dialog box now shows the new response “Attempt remount”, as shown in Figure 3-48 on page 87.

To associate the “Attempt remount” response with the “Check /work04” condition, select the response, then click the < button.

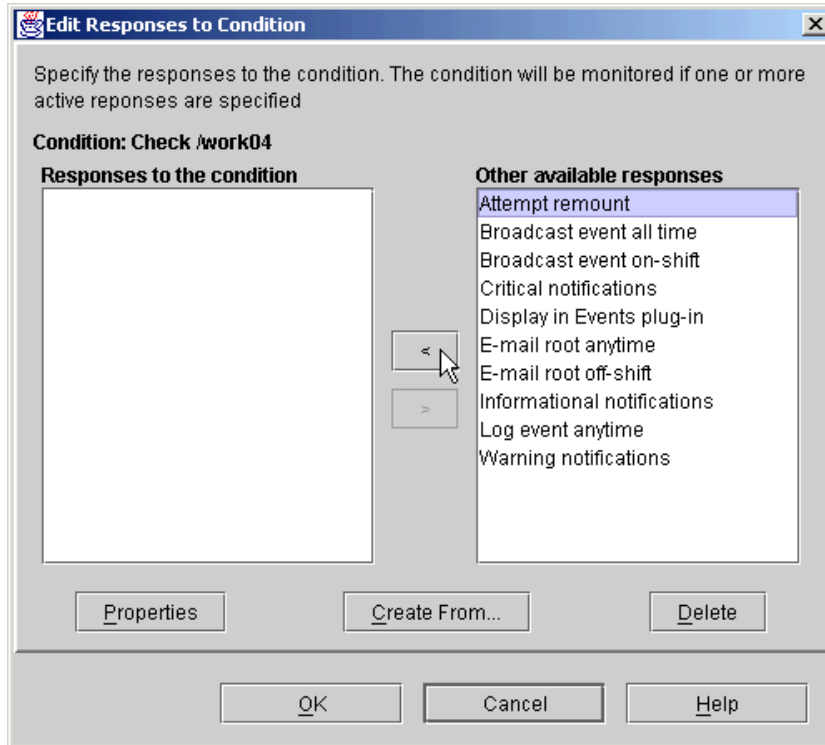

Figure 3-48 New Response: Attempt remount created

8. Then the “Attempt remount” response will appear in the “Responses to the condition” field, as shown in Figure 3-49 on page 88.
Click OK to make this association take effect.

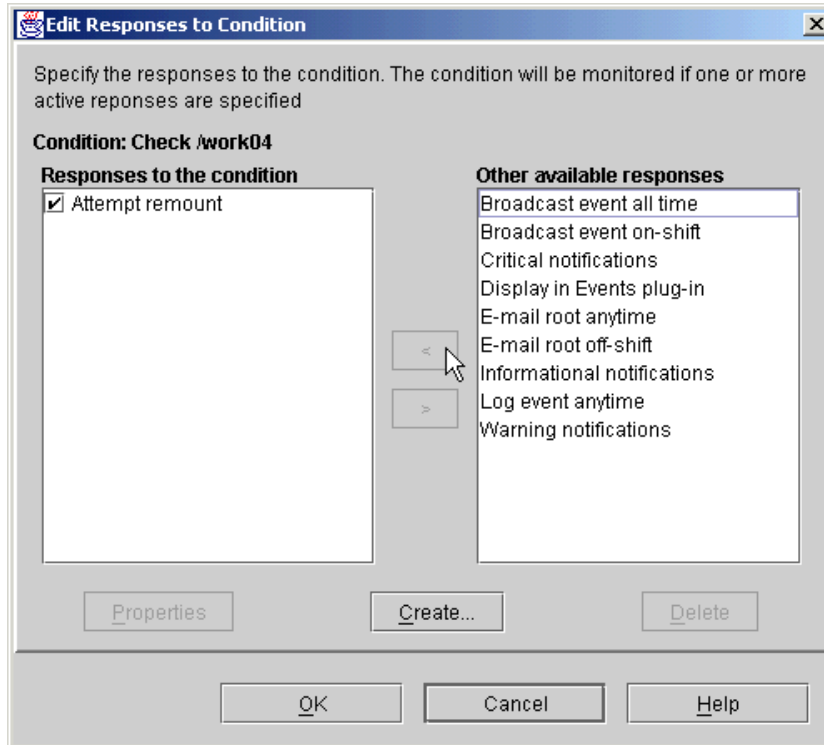

Figure 3-49 New Response: Attempt remount selected as a response

Once you have associated one or more responses with a condition, monitoring is started and a message is displayed as shown in Figure 3-50 on page 89.

At this point, the “Check /work04” condition is being monitored and the associated response will be performed if the operational state of /work04 changes.

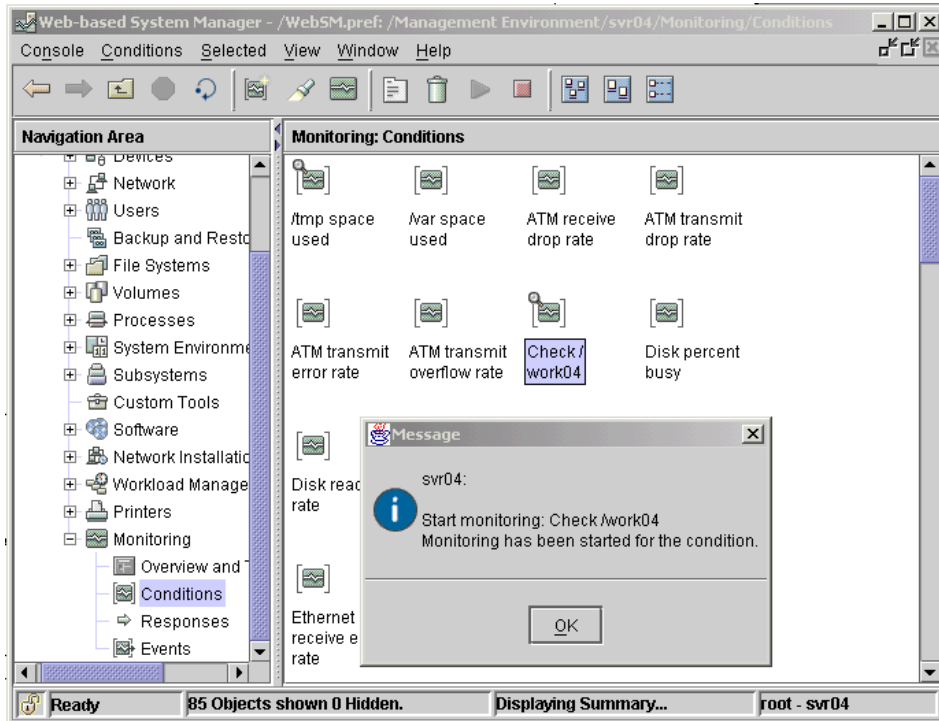

Figure 3-50 New condition starts monitoring

3.4.3 The /home/remount script

The /home/remount script shown in Example 3-2 on page 90 will perform the following several activities if an event or rearm event for the monitoring condition “Check /work04” is detected by RMC:

1. Prints several environment values provided by RMC. When the script runs, the output is sent to the /tmp/inform file.
2. Checks if the event is a rearm event. If this is a rearm, the script just exits.
3. If this is an event, the script attempts to mount /work04 and, if successful, this will cause a rearm event.
4. Checks the return code of the mount. If the command fails, then a diagnostics message is printed. It would be a good idea to issue `snmp -gbc` in the script to gather information for problem diagnosis.
5. If the command is succeeds, the relevant messages are printed.

Example 3-2 The /home/remount script

```
#!/bin/ksh

echo " " >> /tmp/inform
echo An RMC event has occurred. >> /tmp/inform
echo The information is shown below: >> /tmp/inform
echo " " >> /tmp/inform
echo Condition name: $ERRM_COND_NAME >> /tmp/inform
echo Condition severity: $ERRM_COND_SEVERITY >> /tmp/inform
echo Resource name: $ERRM_RSRC_NAME >> /tmp/inform
echo Resource class: $ERRM_RSRC_CLASS_NAME >> /tmp/inform
echo Time of event: $ERRM_TIME >> /tmp/inform
echo Event type: $ERRM_TYPE >> /tmp/inform
echo Event expression: $ERRM_EXPR >> /tmp/inform
echo " " >> /tmp/inform

if [ "$ERRM_TYPE" = "Rearm event" ]
then
    echo "This is a rearm event, just exit!" >> /tmp/inform
    echo " " >> /tmp/inform
    exit 0
fi

echo "Attempting to resolve the problem (simple case)" >> /tmp/inform
echo Issuing a mount command on $ERRM_RSRC_NAME >> /tmp/inform
echo Command is: mount $ERRM_RSRC_NAME >> /tmp/inform
#
mount $ERRM_RSRC_NAME >> /tmp/inform 2>&1
RC=$?
#
# Check the return code
#
if [ "$RC" != "0" ]
then
    echo "FAILED :-( " >> /tmp/inform
    exit 1
fi
#
echo mount succeeded -the problem is fixed! >> /tmp/inform
echo "(If only all other problems were as easy ;-)" >> /tmp/inform
echo " " >> /tmp/inform
exit 0
```

3.4.4 Generating the event

RMC resource monitoring is performed in a polling rather than event driven way, and the period between updates for the File System resource class is 60

seconds. Therefore, once /work04 is unmounted, there will be a period of up to 60 seconds before RMC is aware of the change of state (event) and, following the response, it will take up to 60 seconds again before RMC is aware that the resource is available (rearm event).

When the condition “Check /work04” is being monitored, you can easily trigger the response “Attempt remount” by issuing `umount /work04`.

Once the event has occurred, the /home/remount script logs messages generated by both the event and the rearmed event in the /tmp/inform file, as shown in the following example:

```
An RMC event has occurred.  
The information is shown below:
```

```
Condition name: Check /work04  
Condition severity: Warning  
Resource name: /work04  
Resource class: File System  
Time of event: 1023645967,14549  
Event type: Event  
Event expression: OpState != 1
```

```
Attempting to resolve the problem (simple case)  
Issuing a mount command on /work04  
Command is: mount /work04  
mount succeeded -the problem is fixed!  
(If only all other problems were as easy ;-)
```

```
An RMC event has occurred.  
The information is shown below:
```

```
Condition name: Check /work04  
Condition severity: Warning  
Resource name: /work04  
Resource class: File System  
Time of event: 1023646027,22140  
Event type: Rearm event  
Event expression: OpState == 1
```

```
This is a rearmed event, just exit!
```

You can also view the events using the Web-based System Manager by selecting the Monitoring: Events plug-in and the View All Events icon, as shown in Figure 3-51 on page 92.

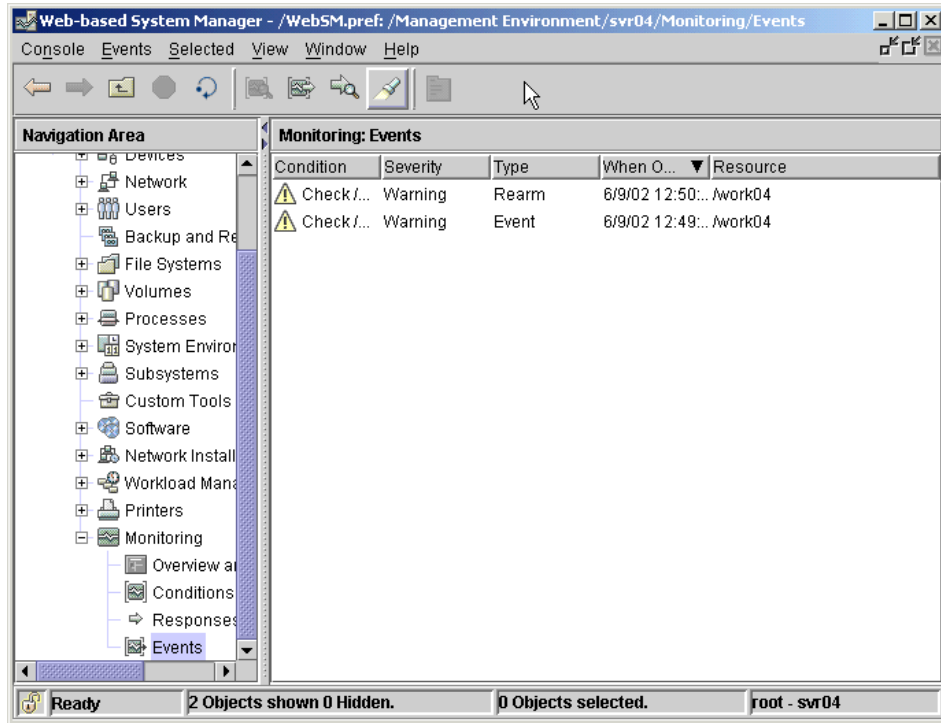

Figure 3-51 Monitoring: Events window (all events)



RMC command line interface

This chapter focuses on the use of the RMC command line interface, presenting several examples of their use in our test environment, which is configured as shown in Section 4.1, “Test environment” on page 94.

The following two sections provide you with general concepts of the RMC command line interface usage:

- ▶ Section 4.2, “Common variables and command flags” on page 95
- ▶ Section 4.3, “A peer domain cluster setup” on page 106

The rest of sections in this chapter present a significant subset of the RSCT Resource Monitoring and Control commands, grouped by component: SRC, RMC, ERRM, and other resource monitors.

The last section, Section 4.10, “Additional security configuration” on page 143, explains the concept of security function that is provided by RMC and how to configure it on the stand-alone servers.

For further information about RMC commands and their usage, please refer to the *IBM RSCT for AIX: Technical Reference, SA22-7890*.

4.1 Test environment

The test environment consists of four RS/6000 servers, as shown in Figure 4-1. The server `svr01` is configured as a stand-alone RMC node, while `svr02`, `svr04`, and `svr05` are configured as members of a peer domain. The host name resolution¹⁵ is done by DNS and all the servers are defined in the `itsc.austin.ibm.com` DNS domain. We refer to the servers either by their short names or fully qualified domain names (FQDNs) in this chapter.

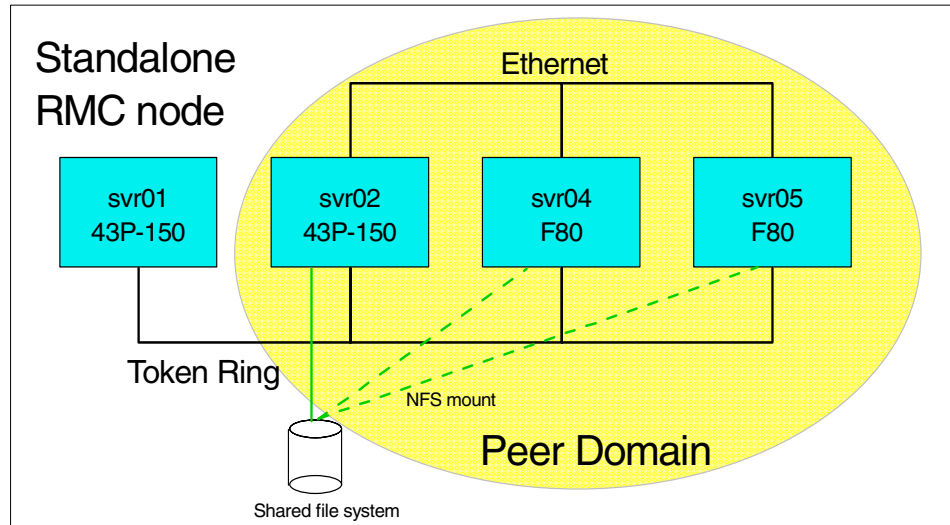

Figure 4-1 RMC test environment

A NFS exported file system, `/SharedTools`, is defined on `svr02` to hold common files, and `svr04` and `svr05` mount this file system remotely. Although the setup of a cluster does *not* require the existence of a shared data storage, we have decided to share files among the cluster nodes for ease of use. Any script that will be defined for the customization of RMC and that is likely to be used on any cluster node will be placed in this shared file system.

For systems where security is strongly concerned, we recommend you use `rsync` or SUP (Software Update Protocol) to synchronize files among servers. For further information about these tools, please refer to *Managing AIX Server Farms*, SG24-6606.

Please note all the examples in this chapter are executed as the root user, except for Section 4.10, “Additional security configuration” on page 143.

¹⁵ The `hostname` command returns FQDN on these servers.

4.2 Common variables and command flags

RSCT Resource Monitoring and Control consists of many components: the RMC subsystem (the `ctrmc` daemon), resource managers, and so on. Each component has its own interface, which follows general rules common to all RMC components, as explained in *IBM RSCT for AIX: Technical Reference*, SA22-7890.

In this section, we explain the most commonly applied rules of these variables and command flags.

Note: Throughout this chapter, besides Section 4.10, “Additional security configuration” on page 143, we present examples for the general case of a peer domain environment. We therefore often refer to servers as *nodes*. However, RMC can also be used in a stand-alone environment, and any further statement related to a node also applies to a *stand-alone server*.

4.2.1 Environment variables

RMC is a distributed environment, where commands can be executed on any node in a cluster to act on any node in the cluster. Two environment variables, `CT_CONTACT` and `CT_MANAGEMENT_SCOPE`, control the behavior of all RMC commands with regard to the *geographical* aspects of RMC. However, some CLI commands, such as configuration manager CLI, ignore `CT_MANAGEMENT_SCOPE`. Therefore, you must consult with the command reference for each command before using that command.

In a stand-alone environment, these variables should be left undefined so that the CLI commands select the default behavior.

In a cluster environment, the end user may be using the CLI on a node that is not where he wants the command to be executed (for acting on resources on one or many other nodes).

Note: `CT_CONTACT` and `CT_MANAGEMENT_SCOPE` are only applicable to the CLI. They do not affect the Web-based System Manager GUI.

CT_CONTACT

This variable defines where the command will be executed. It should contain the host name or the IP address of the host where the command will be executed. If you are not logged on the target node, the CLI contacts the RMC daemon on the target host specified by `CT_CONTACT` and passes it the commands to be

executed. If the variable is unset, the default is to execute the command on the local node.

In Example 4-1, you are logged onto server svr04 and have issued the `lsrsrc` command to display the Name attribute of the IBM.Host resource locally known by the RMC subsystem on svr04. After changing the `CT_CONTACT` variable to svr02, the same command is executed on svr02 while you are still logged on svr04.

Example 4-1 Impact of CT_CONTACT on command results

```
# hostname
svr04.itsc.austin.ibm.com
# echo $CT_CONTACT
... nothing printed ...
# lsrsrc IBM.Host Name
Resource Persistent Attributes for: IBM.Host
resource 1:
    Name = "svr04.itsc.austin.ibm.com"
# export CT_CONTACT=svr02
# lsrsrc IBM.Host Name
Resource Persistent Attributes for: IBM.Host
resource 1:
    Name = "svr02.itsc.austin.ibm.com"
```

Figure 4-2 on page 97 illustrates the concept of `CT_CONTACT`. The arrow A represents the command with `CT_CONTACT` unset, while the arrow B represents the command with `CT_CONTACT` set to svr02.

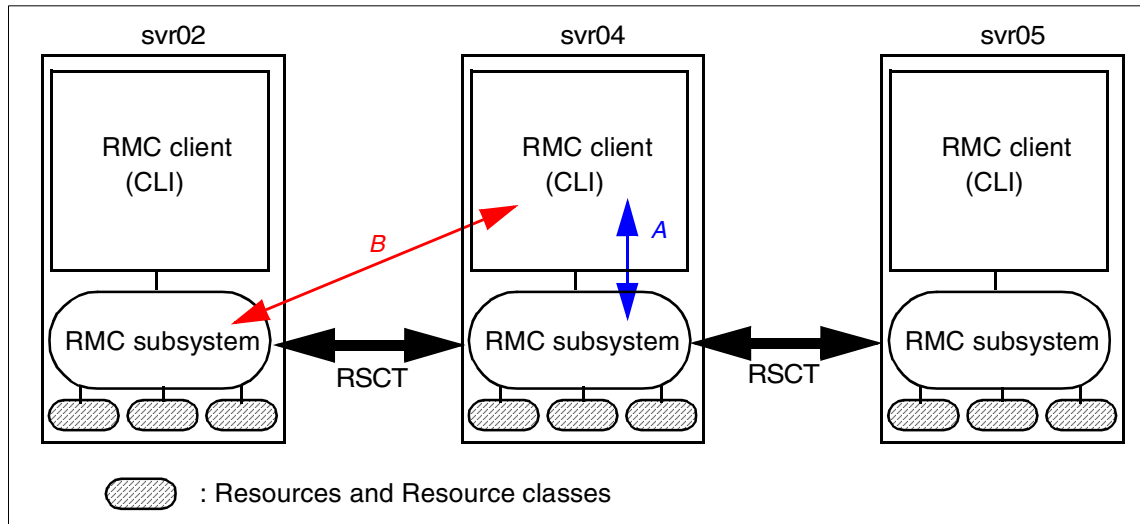

Figure 4-2 The concept of CT_CONTACT

CT_MANAGEMENT_SCOPE

This variable specifies whether commands apply to only local resources or to resources located on the other nodes in the cluster. This variable can be set to an integer value of 0, 1, 2, or 3.

Table 4-1 CT_MANAGEMENT_SCOPE

Value	Where commands refer to
0 or 1	Resources on local node only
2	Resources on all the nodes in a peer domain
3	Resources on all the nodes in a management domain

If the CT_MANAGEMENT_SCOPE variable is not set to any value, the default value is 0, therefore commands refer to resources on the local node only.

In Example 4-2, you execute the `lsrsrc` command on svr02, as implied by the CT_CONTACT variable settings. By simply changing the CT_MANAGEMENT_SCOPE variable to 0 or 2, you can list, with the same command, the name of all hosts known respectively to the default scope or the entire peer domain.

Example 4-2 Impact of CT_MANAGEMENT_SCOPE variable

```
# echo $CT_CONTACT
svr02
```

```

# export CT_MANAGEMENT_SCOPE=0
# lsrsrc IBM.Host Name
Resource Persistent Attributes for: IBM.Host
resource 1:
    Name = "svr02.itsc.austin.ibm.com"
# export CT_MANAGEMENT_SCOPE=2
# lsrsrc IBM.Host Name
Resource Persistent Attributes for: IBM.Host
resource 1:
    Name = "svr05.itsc.austin.ibm.com"
resource 2:
    Name = "svr04.itsc.austin.ibm.com"
resource 3:
    Name = "svr02.itsc.austin.ibm.com"

```

Figure 4-3 illustrates the concept of CT_MANAGEMENT_SCOPE. The arrow A represents the reference to the resources with CT_MANAGEMENT_SCOPE set to 0, while the three arrows shown as B represents the reference to the resources with CT_MANAGEMENT_SCOPE set to 2 on svr02.

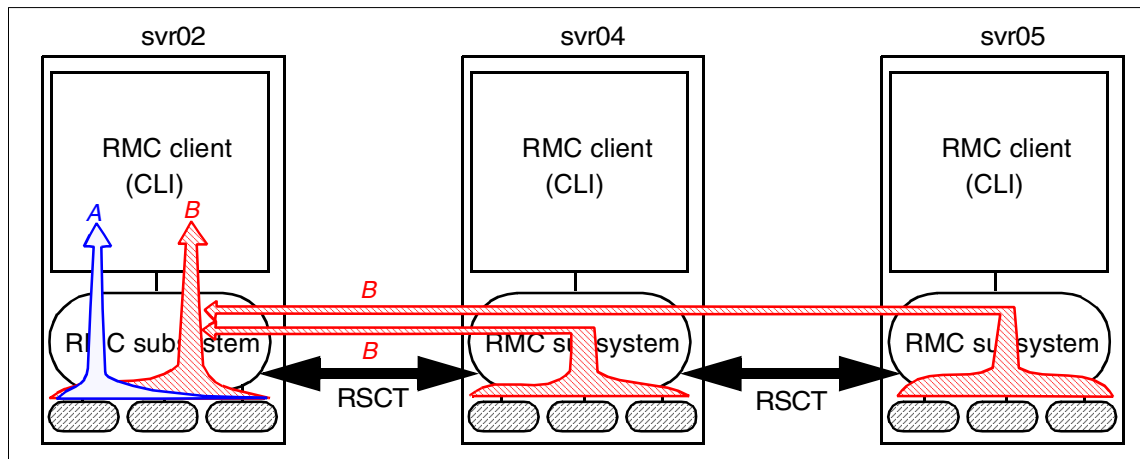

Figure 4-3 The concept of CT_MANAGEMENT_SCOPE

Please note this example does not show the host name where the command is issued, though CT_CONTACT specifies where the command is executed (in this example on svr02). Therefore you will see the same result regardless on which node you have issued this command when CT_MANAGEMENT_SCOPE is set to 2.

4.2.2 Command flags and pattern match operators

Most RMC commands accept the following commonly used command flags:

Display format	-l, -V, -t, -x, -d, and -D
Help	-h
Selection	-s

The -s flag takes a *selection string* argument that can contain at least one expression.

Display format

Most commands support the same flags to specify the output format. The -l and -V flags are used for interactive purpose, and display respectively long and verbose results. The -t, -x, -d, or -D flags are more commonly used within scripts, yielding results in tabular format, without header, with predefined (colon) or user specified field delimiter, that are easier to parse than the default results.

Example 4-3 shows the output of the `lsrsrc` command, with the same arguments but different display format flags.

Example 4-3 Impact of display for flags on the lsrsrc command

```
# lsrsrc -l IBM.Host NodeNameList NumProcessors RealMemSize OSName
Resource Persistent Attributes for: IBM.Host
resource 1:
    NodeNameList = {"svr04.itsc.austin.ibm.com"}
    NumProcessors = 4
    RealMemSize = 1073696768
    OSName = "AIX"
# lsrsrc -t IBM.Host NodeNameList NumProcessors RealMemSize OSName
Resource Persistent Attributes for: IBM.Host
NodeNameList NumProcessors RealMemSize OSName
{"svr04.itsc.austin.ibm.com"} 4 1073696768 "AIX"
# lsrsrc -V IBM.Host NodeNameList NumProcessors RealMemSize OSName
```

Environment Variables being used are:

```
CT_CONTACT = svr04
CT_MANAGEMENT_SCOPE = 1
```

Resource Persistent Attributes for: IBM.Host

```
resource 1:
    NodeNameList = {"svr04.itsc.austin.ibm.com"}
    NumProcessors = 4
    RealMemSize = 1073696768
    OSName = "AIX"
# lsrsrc -d IBM.Host NodeNameList NumProcessors RealMemSize OSName
```

```
Resource Persistent Attributes for: IBM.Host
NodeNameList:NumProcessors:RealMemSize:OSName:
{"svr04.itsc.austin.ibm.com"}:4:1073696768:"AIX":
```

Help

The `-h` flag displays the command syntax and usage on the standard output.

Selection

When a command applies to a whole class and you want to restrict the command to a subset of the resources in the class, you must provide a selection mechanism to identify the appropriate targets. A first mechanism is to use the `CT_CONTACT` and `CT_MANAGEMENT_SCOPE` variables. To further refine the selection, you can use the `-s` option, followed by a selection string.

The selection string is an expression that is evaluated against each resource or class. The selection string is made of variables, operators and constants. The variables refer to persistent attributes of the target resource or class. Selection cannot be performed on dynamic attributes.

Starting from Example 4-4 to Example 4-12 on page 106, we want to know the percentage of disk space used on a set of all file systems. Therefore, we use the same settings of the `CT_CONTACT` and `CT_MANAGEMENT_SCOPE` variables throughout all these examples and changes the selection string.

First, in Example 4-4, no selection string is used, and the seven file systems in the management scope are listed.

Example 4-4 List attributes without selection

```
# lsrsrc IBM.FileSystem Name PercentTotUsed
Resource Persistent and Dynamic Attributes for: IBM.FileSystem
resource 1:
    Name           = "/work04"
    PercentTotUsed = 0
resource 2:
    Name           = "/opt"
    PercentTotUsed = 37
resource 3:
    Name           = "/tmp"
    PercentTotUsed = 17
resource 4:
    Name           = "/var"
    PercentTotUsed = 86
resource 5:
    Name           = "/usr"
    PercentTotUsed = 89
```

```

resource 6:
    Name           = "/home"
    PercentTotUsed = 4
resource 7:
    Name           = "/"
    PercentTotUsed = 75

```

The file system resources have a persistent attribute, named *Mount*, indicating if the file system will be mounted at boot time. This attribute is a string, and can have values “true”, “false”, or “automatic”. Please note the double quote around the string: they need to be part of the selection.

In Example 4-5, we want to retrieve the same information, but only for the file systems that are mounted at boot time, and use a basic selection string to filter only the files with this attribute value set to “true”. Because the string constant is enclosed within double quotes, there is no ambiguity about the exact string: blank spaces around the == test operator can be used; they are not mandatory but helps the readability of the command line syntax.

Example 4-5 Selection with a basic test against a string constant

```

# lsrsrc -s 'Mount == "true"' IBM.FileSystem Name PercentTotUsed
Resource Persistent and Dynamic Attributes for: IBM.FileSystem
resource 1:
    Name           = "/opt"
    PercentTotUsed = 37
resource 2:
    Name           = "/home"
    PercentTotUsed = 4

```

The selection string can contain more complex expressions. In Example 4-6, we only care for the disk usage of file systems smaller than 40000 blocks, and specify a selection strings testing two attributes. The first command displays the correct result while the second command returns error messages; because attributes names are case sensitive, the “size” variable is not recognized as a valid persistent attribute to test.

Example 4-6 Selection with compound expression

```

# lsrsrc -s 'Mount=="true" && Size < 40000' IBM.FileSystem Name PercentTotUsed Size
Resource Persistent and Dynamic Attributes for: IBM.FileSystem
resource 1:
    Name           = "/home"
    PercentTotUsed = 4
    Size           = 32768
# lsrsrc -s 'Mount=="true" && size < 40000' IBM.FileSystem Name PercentTotUsed Size
lsrsrc: 2612-019 The selection string specified with the -s flag contains invalid syntax.

```

2641-005 The variable name "size" is not recognized.
lsrsrc: 2612-019 The selection string specified with the -s flag contains invalid syntax.
2641-005 The variable name "size" is not recognized.
Resource Persistent and Dynamic Attributes for: IBM.FileSystem

Error messages can sometime be misleading. In Example 4-7, the system returns the same error message as in Example 4-6 on page 101 when the attribute name was mistyped. The system complains that the PercentTotUsed attribute is not recognized even though it is a valid attribute name. In fact, the error is due to the fact that PercentTotUsed is a dynamic attribute while only persistent attributes names are allowed in selection strings.

Example 4-7 Selection string referring to a dynamic attribute

```
# lsrsrc -s 'PercentTotUsed < 50' IBM.FileSystem Name PercentTotUsed
lsrsrc: 2612-019 The selection string specified with the -s flag contains invalid syntax.
2641-005 The variable name "PercentTotUsed" is not recognized.
lsrsrc: 2612-019 The selection string specified with the -s flag contains invalid syntax.
2641-005 The variable name "PercentTotUsed" is not recognized.
Resource Persistent and Dynamic Attributes for: IBM.FileSystem
```

In addition to a basic comparison of variables with constants, more sophisticated expressions can be used. In Example 4-8, the command contains an operation involving two variables (MountPoint and MountDir).

Example 4-8 Selection string using several variables and pattern matching

```
# lsrsrc -s 'MountPoint == MountDir && Mount == "true"' IBM.FileSystem Name PercentTotUsed
Resource Persistent and Dynamic Attributes for: IBM.FileSystem
resource 1:
    Name          = "/opt"
    PercentTotUsed = 37
resource 2:
    Name          = "/home"
    PercentTotUsed = 4
```

Pattern match operators

Pattern matching with regular expressions is also supported in selections. However, the behavior may be different from the behavior of AIX regular expressions pattern matching.

Note: We strongly recommend that you be familiar with various pattern matching operators before using regular expressions, and check that the result is what you expect.

There are two pattern match operators, =~ and =?, and two not pattern match operators, !~ and ~?. The =~ and !~ operators apply to operators using the same extended regular expression syntax as the AIX **awk** or **grep** commands do, while =? and !? apply to operands using the SQL-like syntax.

The =~ and !~ operators match substrings, while the SQL-like =? and !? operators match full strings.

When using the extended regular expression operators =~ and !~ with wild cards, you should use:

- ▶ The dot (.) to match exactly one character.
- ▶ The star (*) to match zero or more occurrences of the preceding characters.

With the SQL-like syntax operators, =~ and !~, you should use the following wild card characters:

- ▶ The percent sign (%) matches zero or more characters.
- ▶ The underscore (_) matches exactly one character.
- ▶ The percentage and underscore characters can be quoted with the pound sign (#) to override their special meaning.

Note: We recommend that you do not mix operators of one category (regex or SQL) with wild cards of the other category.

Example 4-9 shows that mixing the SQL-like pattern match operator =? with either the AIX regular expression syntax or the SQL-like syntax wild characters returns different outputs

Example 4-9 Mixing supported syntax with pattern matching operators

```
# lsrsrc -s 'Mount =? "t.*"' IBM.FileSystem Name Mount
Resource Persistent Attributes for: IBM.FileSystem
# lsrsrc -s 'Mount =? "t%"' IBM.FileSystem Name Mount
Resource Persistent Attributes for: IBM.FileSystem
resource 1:
    Name = "/opt"
    Mount = "true"
resource 2:
    Name = "/home"
    Mount = "true"
```

We will finish this section about selection string with an example showing the different behavior of the =~, =?, !~, and !? operators.

First, Example 4-10 lists all file systems known to RMC. Please notice that the Mount attribute of the resources takes one of the values: “true”, “automatic”, or “false”. The commands in the following examples will apply different pattern matching expressions on the Mount attribute so that you can compare them to the results shown in Example 4-10.

Example 4-10 List of all known file systems

```
# lsrsrc IBM.FileSystem Name Mount
Resource Persistent Attributes for: IBM.FileSystem
resource 1:
    Name = "/work04"
    Mount = "false"
resource 2:
    Name = "/opt"
    Mount = "true"
resource 3:
    Name = "/tmp"
    Mount = "automatic"
resource 4:
    Name = "/var"
    Mount = "automatic"
resource 5:
    Name = "/usr"
    Mount = "automatic"
resource 6:
    Name = "/home"
    Mount = "true"
resource 7:
    Name = "/"
    Mount = "automatic"
```

Example 4-11 shows that =~ and !~ match substring of the value contained in the Mount attributes, while =? and !? exactly match the entire string value contained in the Mount attribute.

Example 4-11 Using the four pattern matching operators

```
# lsrsrc -s 'Mount =~ "#t.*"' IBM.FileSystem Name Mount
Resource Persistent Attributes for: IBM.FileSystem
resource 1:
    Name = "/opt"
    Mount = "true"
resource 2:
    Name = "/tmp"
    Mount = "automatic"
resource 3:
    Name = "/var"
    Mount = "automatic"
```

```

resource 4:
    Name = "/usr"
    Mount = "automatic"
resource 5:
    Name = "/home"
    Mount = "true"
resource 6:
    Name = "/"
    Mount = "automatic"
# lsrsrc -s 'Mount =? "t%"' IBM.FileSystem Name Mount
Resource Persistent Attributes for: IBM.FileSystem
resource 1:
    Name = "/opt"
    Mount = "true"
resource 2:
    Name = "/home"
    Mount = "true"
# lsrsrc -s 'Mount !~ "t.*"' IBM.FileSystem Name Mount
Resource Persistent Attributes for: IBM.FileSystem
resource 1:
    Name = "/work04"
    Mount = "false"
# lsrsrc -s 'Mount !? "t%"' IBM.FileSystem Name Mount
Resource Persistent Attributes for: IBM.FileSystem
resource 1:
    Name = "/work04"
    Mount = "false"
resource 2:
    Name = "/tmp"
    Mount = "automatic"
resource 3:
    Name = "/var"
    Mount = "automatic"
resource 4:
    Name = "/usr"
    Mount = "automatic"
resource 5:
    Name = "/"
    Mount = "automatic"

```

If you prefer to use the AIX regular expression to match full strings, you will need to use the anchors, such as the caret character (^), to specify the beginning of the string. In Example 4-12 on page 106, “^t.*” does not match the string “automatic” like “t.*” does.

Example 4-12 Use of ^ in extended regular expression

```
# lsrsrc -s 'Mount =~ "^t.*"' IBM.FileSystem Name Mount
Resource Persistent Attributes for: IBM.FileSystem
resource 1:
    Name = "/WT"
    Mount = "true"
resource 2:
    Name = "/AIX_updates"
    Mount = "true"
resource 3:
    Name = "/opt"
    Mount = "true"
resource 4:
    Name = "/home"
    Mount = "true"
```

For a complete list of all expressions operators supported by RMC, please refer to Chapter 3 in the *IBM RSCT for AIX: Guide and Reference*, SA22-7889.

4.2.3 Persistent property value file

The last feature we present in this section is the file format called *Resource_Data_Input*. Files with this format can be used to pass resource and resource classes property values, either to define new resources or to change persistent property values.

Only four commands uses this file format. The **lsrsrctdef** and **lsactdef** commands, which respectively list resource (class) definition and action definitions, can generate an output using *Resource_Data_Input* when used with the **-i** flag. You can redirect the command's standard output to a file, then edit the file. If the **-f** flag is specified, the **mkrsrc** and **chrsrc** commands use the file name specified on the command line argument as their input.

4.3 A peer domain cluster setup

This section explains how to configure a peer domain cluster, described in Section 4.1, "Test environment" on page 94. All examples in Section 4.4, "SRC commands" on page 112 and later assume this configuration.

However, if you do not intend to use peer domain clusters and are not interested in cluster configuration commands, you can skip this section.

4.3.1 Required filesets

Before you configure the cluster environment, you need to ensure that the required filesets are installed, as explained in Section 1.4, “RMC software packaging” on page 8.

4.3.2 Preparing your node security

When a cluster is operational, data is communicated between nodes and RSCT uses a public-key based security mechanism to authenticate the exchange of messages between the nodes. The first step in setting up the cluster is to exchange public keys between nodes that are to be clustered together.

To execute this step, issue **preprnode** on all nodes using either of the following methods:

- ▶ **preprnode svr02 svr04**
- ▶ **preprnode -f node.list**

Where `node.list` is a text file that contains the list of host names that will belong to the cluster, as shown in the following example:

```
# cat node.list
svr02
svr04
```

The **preprnode** command must be run on every node to be configured in the cluster. In this case, the command was run only on `svr02` and `svr04`. We show later how to add `svr05` to the cluster.

Note: In our test environment, we have stored the `node.list` file on the file systems shared by NFS among all nodes, to ensure the command will take the same set of nodes, and to avoid having to manually transfer the files between the nodes.

4.3.3 Creating the cluster

The nodes that will be taking part in the cluster have exchanged keys and are ready to be added to the cluster. However, before that can be done, the cluster itself (or domain) must be created.

To create a peer domain cluster, issue **mkrpdomain** on one node that is already prepared with **preprnode** using either of the following methods (PD is the cluster name):

- ▶ **mkrpdomain PD svr02 svr04**

► **mkrpdomain PD -f node.list**

This command creates the cluster and defines the nodes as possible members of the cluster. Nodes can be defined within multiple clusters but can only be online with one cluster at a time.

Note: Depending on the performance of your system, **mkrpdomain** may take a little while time to complete.

To check the status of the domain, use **lsrpdomain** to list all known domains and provide a summary of their status:

```
# lsrpdomain
Name OpState RSCTActiveVersion MixedVersions TSPort GSPort
PD   Offline 2.2.1.10           No           12347 12348
```

This shows that domain (cluster) PD has been created but is still in the *offline* state.

4.3.4 Bringing the cluster online

The cluster has been defined but is created in an offline state. To bring the cluster PD online, issue the **startrpdomain** command, as shown in the following example:

```
# startrpdomain PD
```

This command must be run on a node that is defined to the cluster and requests that all nodes defined within the named cluster are brought online.

To check the status of the cluster, use **lsrpdomain**, as shown in the following example:

```
# lsrpdomain
Name OpState RSCTActiveVersion MixedVersions TSPort GSPort
PD   Online 2.2.1.10           No           12347 12348
```

The **startrpdomain** command returns promptly, but it can take a little time before the cluster comes online. If you issue **lsrpdomain** during this transition phase, you might see the following:

```
# lsrpdomain
Name OpState           RSCTActiveVersion MixedVersions TSPort GSPort
PD   Pending online 2.2.1.10           Yes           12347 12348
```

Now the cluster is online, the status of the nodes within the cluster can be displayed with **lsrpnode**, as shown in the following example:

```
# lsrpnode
Name OpState RSCTVersion
svr02 Online 2.2.1.10
svr04 Online 2.2.1.10
```

This example shows that both nodes are online and can be used for cluster operations.

4.3.5 Adding a node to the cluster

The cluster PD is online and has two nodes defined (svr02 and svr04), but this is not a static environment. If you decide that you need to add a new node to the cluster, this can be performed without stopping the cluster. The important step to remember is shown in Section 4.3.2, “Preparing your node security” on page 107. If you are adding a node to a cluster, you must execute **preprnode** with the names of all the online nodes on the new node. In this example, we are going to add the node svr05 into the cluster, so must run **preprnode svr02 svr04 svr05** on svr05 as the first step.

Once the security environment is configured, the next step is to add the node to the online cluster. The command **addrpnode** performs this operation, and must be run on a node that is online in the cluster you are modifying. Nodes may be defined in several clusters simultaneously, but can only be online to one cluster at any time.

To add the node svr05 to the online cluster (PD), execute the following on an *online* node *in* cluster PD.

```
# addrpnode svr05
```

Depending on the configuration of your system, **addrpnode** may take a little while to complete.

When **addrpnode** has completed, you can list all known nodes and their status with the **lsrpnode** command. At this point in time, svr05 is part of cluster PD, but is not yet online. This means that the output of **lsrpnode** and **lsrpdomain** depends on where the commands are run, for example:

► On svr05

```
# lsrpdomain
Name OpState RSCTActiveVersion MixedVersions TSPort GSPort
PD Offline 2.2.1.10 No 12347 12348
# lsrpnode
lsrpnode: 2602-021 There are no nodes in the peer domain or an online peer
domain does not exist.
```

► On svr04

```
# lsrpdomain
Name OpState RSCTActiveVersion MixedVersions TSPort GSPort
PD   Online  2.2.1.10           No           12347  12348
# lsrpnode
Name OpState RSCTVersion
svr05 Offline 2.2.1.10
svr02 Online  2.2.1.10
svr04 Online  2.2.1.10
```

Both of the above examples demonstrate the correct behavior and tell you the importance of using the correct commands at the correct time on the correct node.

4.3.6 Bringing a node online

The node svr05 is now defined in cluster PD but is not yet online. To bring a node online, you can use the command `startlrnode` and this must be executed on an *online* node in the cluster as follows:

```
# startlrnode svr05
```

The **startlrnode** command returns promptly, but it may take a short while before the node is brought online.

To show the status of the cluster and nodes, do the following task:

```
# lsrpdomain
Name OpState RSCTActiveVersion MixedVersions TSPort GSPort
PD   Online  2.2.1.10           No           12347  12348
# lsrpnode
Name OpState RSCTVersion
svr05 Online  2.2.1.10
svr02 Online  2.2.1.10
svr04 Online  2.2.1.10
```

Note: If you have a number of nodes to bring online in the cluster, you can use the **startlrpdomain** command to bring them all online without having to specify the node names.

4.3.7 Stopping (offline) a node in the cluster

The **stoplrnode** command can be used to put a node in the *offline* state. This command can be executed from any *online* node in the cluster as follows. This example was run on svr04 and, if run on svr05, the final **lsrpnode** would fail (correctly), because svr05 is not online to a cluster anymore.

For example:

```
# lsrpnode
Name OpState RSCTVersion
svr05 Online 2.2.1.10
svr02 Online 2.2.1.10
svr04 Online 2.2.1.10
# stoprnode svr05
# lsrpnode
Name OpState RSCTVersion
svr05 Offline 2.2.1.10
svr02 Online 2.2.1.10
svr04 Online 2.2.1.10
```

The **stoprnode** command returns promptly, but it may take a short while before the node is brought offline.

4.3.8 Removing a node from the cluster

If you must remove a node from the cluster, the node must first be in the offline state, and then it can be removed with the **rmrnode** command. This must be executed on an *online* node of the cluster:

```
# rmrnode svr05
# lsrpnode
Name OpState RSCTVersion
svr02 Online 2.2.1.10
svr04 Online 2.2.1.10
```

Depending on the configuration of your system, **rmrnode** may take a little while to complete.

4.3.9 Stopping (offline) a cluster

The **stoprpdomain** command is used to take all the online nodes of a cluster offline. It must be run on an *online* node, as shown in the following example:

```
# stoprpdomain PD
# lsrpdomain
Name OpState RSCTActiveVersion MixedVersions TSPort GSPort
PD Offline 2.2.1.10 Yes 12347 12348
```

The cluster configuration is preserved after the cluster status is changed to offline.

4.3.10 Removing a cluster

Clusters and defined nodes may be changed while the cluster is running. We anticipate that the operational environment may support a different dynamic environment. RSCT provides the functionality to allow nodes to be added and removed from clusters as required. If a cluster must be deleted and the configuration information removed, `rmrpdomain` can be used.

To remove a peer domain cluster, do the following:

1. Bring the peer domain online, if it is not online yet.
2. Execute the `rmrpdomain` command on an online node:

```
# rmrpdomain PD
rmrpdomain: 2602-021 There are no nodes in the peer domain or an online
peer domain does not exist.
```

3. If there is any node that is not network accessible when the peer domain is being removed, execute the `rmrpdomain` command with the `-f` option on each node to clean up the cluster configuration on the node:

```
# rmrpdomain -f PD
```

4.4 SRC commands

AIX has the system resource controller (SRC), which provides a consistent controlling method for various system daemon processes (referred to as *subsystems*). Although SRC is generic to the other AIX subsystems, and not only applicable to RMC, it is important to understand how the RMC subsystem is controlled by several commands.

4.4.1 lssrc

The `lssrc` command provided by AIX SRC can be used to check if the RMC subsystems are active. Example 4-13 shows the subsystems belong to either of the `rsct` or `rsct_rm` subsystem groups.

Example 4-13 Checking the RMC subsystems

```
# lssrc -g rsct
Subsystem      Group          PID           Status
ctcas          rsct           17802         active
ctrmc          rsct           24950         active
# lssrc -g rsct_rm
Subsystem      Group          PID           Status
IBM.ConfigRM  rsct_rm       11618         active
IBM.ERRM      rsct_rm       21350         active
```

IBM.AuditRM	rsct_rm	22018	active
IBM.FSRM	rsct_rm	20674	active
IBM.CSMAgentRM	rsct_rm	22900	active
IBM.ServiceRM	rsct_rm	16326	active
IBM.HostRM	rsct_rm	20742	active
IBM.SensorRM	rsct_rm		inoperative

The ctrmc subsystem, which we refer to as the RMC subsystem in this redbook, is instantiated as the rmcd daemon (/usr/sbin/rsct/bin/rmcd).

A security subsystem, ctcas, is in charge of authentication in the cluster, by means of UNIX identity-based credentials. The ctcas subsystem is instantiated as the ctcasd daemon (/usr/sbin/rsct/bin/ctcasd).

Both the ctrmc and ctcas subsystems belong to the rsct group.

The rsct_rm group contains the resource managers. The names of their subsystem are shown in Figure 2-1 on page 16 and explained in Section 2.3, “Resource managers” on page 23.

4.4.2 nlssrc

In addition to the AIX `lssrc` command, RSCT provides the `nlssrc`¹⁶ command, located in /usr/sbin/rsct/bin/nlssrc. Without the `-c` flag, `nlssrc` behaves the same as `lssrc`. With the `-c` flag, `nlssrc` returns the same information as the `lssrc` command but always in English, regardless if the locale is used on the system.

4.4.3 Other SRC commands

Even if RMC components are subsystems that can be managed with any AIX System Resource Controller (SRC) commands, we recommend you only use the SRC `lssrc` command with these subsystems. Do not use the `startsrc` and `stopsrc` commands to start and stop the RMC daemon, but rather the `rmctr1` (RMC Control) command.

The `refresh` command may be used to force the RMC subsystem to re-read its configuration files, for example, after modifying the security file containing the access control lists.

¹⁶ At the time of writhing this redbook, this command is only applicable to the cthats and cthags subsystems.

4.5 RSCT commands

RSCT provides the user with many commands to control, for example, the Group Services or the Topology Services. We present, in this redbook, the RSCT command **rmcctr1** only as it is related to resource monitoring and control.

The **rmcctr1** command manages both the RMC subsystem and the resource managers subsystem. Depending on the flags passed to the command, it will add or remove the RMC subsystem to or from the subsystem object class, and start or stop the subsystems.

During the AIX installation, the **rmcctr1 -a** command is performed automatically (RSCT is part of the filesets installed by default), and the following entry will be added in the `/etc/inittab`:

```
# grep ctrmc /etc/inittab
ctrmc:2:once:/usr/bin/startsrc -s ctrmc > /dev/console 2>&1
```

Therefore, the RMC subsystem is started by default upon every reboot. There is no need to perform any action to manually start it in normal operation.

The `-s` and `-k` flags start and stop the `ctrmc` only. They have no action on the security subsystem `ctcas` or on resource managers. Once the `ctrmc` subsystem is started, it will start the other components when it needs them. For example, the `ctcas` and `IBM.ERRM` subsystems will be immediately started, while the `IBM.HostRM` subsystem will only be started when there is a need to interact with one of the resources or classes it manages.

Because the `ctcas` and `IBM.ERRM` subsystems are started by `ctrmc` when needed, there is no flag in the **rmcctr1** command to start one of these subsystems.

Both the `-K` and `-z` options stops RMC and the resource managers, but the former is asynchronous while the later is synchronous. With `-z`, the command will not return before all subsystems have actually stopped. the `-K` flag is therefore more suitable for interactive use, while the `-z` options is useful when the **rmcctr1** command is used in scripts where you must be sure that all daemons are stopped before executing another action.

4.6 RMC commands

Because the RMC subsystem is the generic core of RSCT Resource Monitoring and Control, it provides several commands that handle resources classes and resources generally (we refer to these commands as *generic* RMC commands).

All commands described in Section 4.7, “Sensor commands” on page 122 and later are specific to one resource class.

There are five categories of generic RMC commands:

Creation	mkrsrc
Display	lsrsrc, lsrsrccdef, and lsactdef
Modification	chrsrc
Deletion	rmrsrc
Refresh	refrsrc

The **mkrsrc**, **lsactdef**, **chrsrc**, and **rmrsrc** commands are described in the *IBM RSCT for AIX: Technical Reference, SA22-7890*. For all resources that can be created by an end user, RMC provides a resource specific command (for example: **mkcondition** and **mksensor**), which is easier to use than the generic RMC commands. We therefore recommend you use the resource specific commands only.

In this section, we describe the use of **lsrsrc**, **lsrsrccdef**, and **refrsrc**.

4.6.1 lsrsrc

This is the most widely used of all RMC commands. We already presented several examples of **lsrsrc** in Section 4.2, “Common variables and command flags” on page 95. The **lsrsrc** command lists the attributes (and their values) of resources and resources classes.

Classes and resources can have a large number of attributes, and the default behavior of **lsrsrc** is to only display a subset of them. It is important to understand the effect of flags on the returned result.

Note: It may not always be obvious to guess the meaning of an attribute from only its name. Please refer to the *IBM RSCT for AIX: Guide and Reference, SA22-7889* for a detailed description of supported attributes.

The first argument of **lsrsrc** is a resource class name. By default, the result will relate to resources in this class. You need to specify the **-c** flag to retrieve class attributes and values. Example 4-14 on page 116 shows that the **IBM.PagingDevice** class has no public attribute, while resources in this class have three public attributes. This example also shows that server **svr01** has only one paging space defined on logical volume **/dev/hd6**.

Example 4-14 Class attributes versus resource attributes

```
# 1srsrc -c IBM.PagingDevice
Resource Class Persistent Attributes for: IBM.PagingDevice
# 1srsrc IBM.PagingDevice
Resource Persistent Attributes for: IBM.PagingDevice
resource 1:
    Name          = "/dev/hd6"
    NodeNameList = {"svr01.itsc.austin.ibm.com"}
    Size          = 131072
```

Attributes are either persistent (static) or dynamic. If you do not explicitly specify attribute(s) in the command line, the default is to display only persistent attributes. The `-a` flag followed by *p* (persistent), *d* (dynamic) or *b* (both) overrides the default behavior, as shown in Example 4-15. Note that in the last command example, there is no need to specify `-ad` to display the `PctFree` attribute value, because its name is explicitly specified as the command argument.

Example 4-15 Persistent versus dynamic attributes

```
# 1srsrc IBM.PagingDevice
Resource Persistent Attributes for: IBM.PagingDevice
resource 1:
    Name          = "/dev/hd6"
    NodeNameList = {"svr01.itsc.austin.ibm.com"}
    Size          = 131072
# 1srsrc -ad IBM.PagingDevice
Resource Dynamic Attributes for: IBM.PagingDevice
resource 1:
    PctFree = 76
    OpState = 1
# 1srsrc IBM.PagingDevice PctFree
Resource Dynamic Attributes for: IBM.PagingDevice
resource 1:
    PctFree = 76
```

Each attribute has one or more of the following properties: *public*, *read only*, *required for define*, *not valid for define*, *optional for define*, and *selectable*. In most cases, you will only be interested in public and selectable. By default, `1srsrc` displays only public attributes. In general, attributes which are not public are only useful for application developers and not for end users. You need to specify `-p0` to list all attributes. Example 4-16 on page 117 shows that the `IBM.PagingDevice` resources has three non-public attributes.

Example 4-16 Default (public) versus all attributes

```
# lsrsrc IBM.PagingDevice
Resource Persistent Attributes for: IBM.PagingDevice
resource 1:
    Name          = "/dev/hd6"
    NodeNameList  = {"svr01.itsc.austin.ibm.com"}
    Size          = 131072
# lsrsrc -p0 IBM.PagingDevice
Resource Persistent Attributes for: IBM.PagingDevice
resource 1:
    Name          = "/dev/hd6"
    ResourceHandle = "0x600a 0xffff 0x383530da 0x6abe1f4f 0x0e337e5c 0xb3a9cbd6"
    Variety       = 1
    NodeNameList  = {"svr01.itsc.austin.ibm.com"}
    NodeIDs      = {4050197154541477711}
    Size          = 131072
```

In this example, we have chosen a resource class that only contains one resource. In general, this will not be the case, especially in a cluster environment, but you are most likely to be interested in a subset of the resources only. You have to use the `-s` “selection string” flag to select this subset. We have provided several examples of using this flag in Section 4.2, “Common variables and command flags” on page 95. The attributes that can be used in the selection string are those that have the *selectable* property.

One of the non public attributes that can be useful to end users is the `ResourceHandle`. All resources, whatever the class they belong to, have a `ResourceHandle`, which uniquely identifies this resource within the cluster. When dealing with many resources, it can be time consuming and error prone to repeat the same complex selection to refer to one object. Retrieving the `ResourceHandle` of this resource once and for all, and reusing it each time you need to refer to this very resource, will improve your efficiency. This can be specially helpful if you write scripts calling RMC commands.

Example 4-17 on page 118 shows how to store the `ResourceHandle` of a resource in a shell variable to be reused by other commands. The first command stores the value of the `ResourceHandle` in the `RHdl` variable. Note that the command lines spread over three lines, one of which is just a selection string. The `echo` command proves that the variable is correctly set. The `mkcondition` command reuses the `RHdl` shell variable to create a condition, and `lscondition` proves that the previous command was successful.

Example 4-17 Using ResourceHandle across several commands

```
# RHd1=`lsrsrc -x -t \  
    -s 'NodeNameList=="svr04.itsc.austin.ibm.com" AND Name== "/dev/hd6"' \  
    IBM.PagingDevice ResourceHandle`  
# echo $RHd1  
"0x600a 0xffff 0x1e479641 0xfea2a4dc 0x0e338635 0x88a7455e"  
# mkcondition -r IBM.PagingDevice -e "PctFree<50" -s "ResourceHandle==$RHd1" testpg  
# lscondition testpg  
Displaying condition information:  
  
condition 1:  
    Name          = "testpg"  
    Node          = "svr04.itsc.austin.ibm.com"  
... many lines erased here ....
```

Note: Do not hardcode a resource handle in your script. Always retrieve it dynamically and store its value in a shell variable.

It is very important that you understand the exact purpose of a resource class to understand the behavior of the `lsrsrc` command. For example, if you just start to use RMC and you have not yet customized it, using the command `lsrsrc IBM.Program` will return nothing, while you may be expecting a display of all processes currently executing on your server. The `IBM.Program`¹⁷ resource exists so that you can monitor one of its instances. Therefore, the `IBM.Program` resource declares how to recognize a process as being an instance of a program: its executable path name, the name of the user executing it, and so on. An `IBM.Program` resource can therefore exist without being related to any existing process, and be used in RMC tasks. This means that you can use the `IBM.Program` resource to define monitoring conditions, such as the start of a program. If the `IBM.Program` was representing an AIX process, you would not be able to refer to this process before it exists in the system, and therefore you would not be able to create a condition to monitor the start of the process.

The `lsrsrc IBM.Program` command lists the programs that are defined in RMC, and when you just start using RMC, none have been defined yet, which explains why the command returns nothing.

There are two ways to define `IBM.Program` resources. One is to explicitly use the resource creation command `mkrsrc`, but in most cases you will never need it. The other way is to have another command implicitly create the resource for you. This is what happens when you start to monitor a condition referring to an `IBM.Program` resource. If the monitored program resource does not exist, it will

¹⁷ In this context, we use “`IBM.Program` resource” to refer to a resource that belongs to the `IBM.Program` resource class.

be automatically created for you, using the information contained in the definition of the condition, before the condition is activated.

If you only use the implicit way of creating IBM.Programs, **1srsrc IBM.Program** will only display the list of program for which a monitoring condition exists and is activated.

4.6.2 1srsrdef

The **1srsrdef** command returns the description of a resource class or a resource and their attributes.

Note: Do not confuse **1srsrc** with **1srsrdef**. The **1srsrc** command lists the value of attributes specific to each instance of a resource, while **1srsrdef** lists attribute definitions, which are global for all instances.

You can use it when:

- ▶ Creating selection strings
The **1srsrdef** command displays the properties of attributes so that you can find out which attributes are supported within a selection string.
- ▶ Developing new monitoring conditions
The **1srsrdef** command can display the data type of an attribute, necessary to choose the right operands in the condition expressions.
- ▶ Obtain detailed information about a resource
Some attributes names are cryptic, and **1srsrdef** can return a description of the attribute.

As for **1srsrc**, the default behavior is to only display a subset of all information related to the classes or resources.

The **-ap** or **-ad** flags instruct the command to return persistent or dynamic attributes respectively. Unlike **1srsrc**, the **-ab** flag does not exist and you cannot display information for both persistent and dynamic information with only one invocation of **1srsrdef**.

The **-c** flag indicates whether **1srsrdef** returns information pertaining to the class or the resource.

The **-e** flag indicates that the returned information will return the full description of an attribute. This description can be long and is not displayed by default. If you do not have the full RSCT documentation at hand, this is a quick way to get a hint about the use of a flag whose name is not explicit. For example, the

IBM.FileSystem resource has a *Bf* attribute, and it is difficult to guess what it represents. Example 4-18 shows that the Bf attribute indicates whether a file system is big-file-enabled¹⁸ or not.

Example 4-18 Description of the Bf attribute

```
# lsrsrdef -ap -e IBM.FileSystem Bf
Resource Persistent Attribute Definitions for: IBM.FileSystem
attribute 1:
  program_name = "Bf"
  display_name = "Big File Enabled"
  group_name   = "Advanced"
  properties   = {"read_only","public","selectable","inval_for_define"}
  description = "Indicates whether this resource is big-file-enabled or not"
  attribute_id = 18
  group_id    = 1
  data_type   = "char_ptr"
  variety_list = {[1,1],[1,1,4,4]}
  variety_count = 2
  default_value = ""
```

The `lsrsrdef` command also displays public attributes only by default. Using the `-p0` flag, all attributes are displayed.

When applied to a resource class, `lsrsrdef` with the `-c` flag returns the name of the resource manager handling this class in the `mgr_name` entry. Example 4-19 shows that IBM.PagingDevice is managed by the Host resource manager.

Example 4-19 Resource manager in charge of IBM.PagingDevice

```
# lsrsrdef -c IBM.PagingDevice
Resource Class Definition for: IBM.PagingDevice
resource class 1:
  class_name      = "IBM.PagingDevice"
  class_id       = 10
  properties     = {"has_rsrc_insts","mtype_subdivided"}
  display_name   = ""
  description    = ""
  locator        = "NodeNameList"
  class_pattr_count = 1
  class_dattr_count = 3
  class_action_count = 0
  pattr_count    = 5
  dattr_count    = 3
  action_count   = 0
  error_count    = 0
  rsrc_mgr_count = 1
```

¹⁸ This is referred to as the large file enabled feature of JFS.

```
rsrc_mgrs 1:
    mgr_name = "IBM.HostRM"
    first_key = 1
    last_key = 1
```

4.6.3 refsorc

Each resource manager maintains a list of the resources it knows. A resource is a virtual software object that represents one real object in the cluster. For example, there is one IBM.Filesystem resource for each JFS or JFS2 file system that has been defined in your system.

The RSCT Resource Monitoring and Control architecture does not specify how a resource manager has to manage the association between the virtual resource and the real object it represents. In particular, the architecture does not impose real-time constraints or event driven implementation of the resource managers.

As a consequence, there may be some delay between the creation or modification of a real resource and the update of the attributes of the corresponding resource. For example, the Sensor resource manager default refresh rate is once every 60 seconds.

The **refresh** command takes the name of a resource class as its parameter. It forces the resource manager owning this class to detect any changes in the configuration of resources in this class.

The **lsrsrc -x** command returns all the resource class names, as shown in the following example:

```
# lsrsrc -x
"IBM.Association"
"IBM.ATMDevice"
"IBM.AuditLog"
"IBM.AuditLogTemplate"
"IBM.Condition"
"IBM.EthernetDevice"
... many lines are erased ...
```

However, the resource class name is enclosed by the double-quote characters in the output. To chop the double-quote characters returned by **lsrsrc** around the resource class names, you can use **sed**, as shown in the following example:

```
# for i in `lsrsrc -x | sed 's/\\"//g'`
do
    echo $i
done
```

Example 4-20 shows how to refresh all resource classes using `refrsrc` in the *do* loop.

Example 4-20 Refreshing classes with eval

```
# for i in `lsrsrc -x | sed 's/\\"//g'`
do
    refrsrc -V $i
done
Refreshing resource class: IBM.Association
Refreshing resource class: IBM.ATMDevice
Refreshing resource class: IBM.AuditLog
Refreshing resource class: IBM.AuditLogTemplate
... many lines erased here ...
```

Because you cannot set the resource managers refresh rate, if you are in an environment where resource configurations change often, we recommend that you force a refresh of the classes if you execute several commands relying on an accurate list of resources within a short time interval. This can be the case, for example, in a script that would modify your configuration (adding file system, changing TCP/IP adapters settings, and so on) and use RMC commands.

4.7 Sensor commands

When you want to monitor a part of the AIX environment for which RMC does not provide a predefined resource class or attribute, you can create your own resource, called a sensor, using the Sensor resource manager. A sensor is a command that will be periodically executed, returning a set of values that can be monitored with the Event Response resource manager.

The Sensor resource manager provides four commands to list, create, modify or remove sensors; `lsensor`, `mksensor`, `chsensor`, and `rmsensor`.

Section 5.2, “Advanced monitoring” on page 156 contains detailed examples of the use of these sensor commands.

A sensor refers to a program by the full path name. Therefore, a sensor must be defined on the node where this program is stored. Usually, this program is not provided by the operating system, but is a user defined script.

Note: In our test environment, all scripts used as sensors are stored in the NFS file systems shared among all nodes in the cluster, so that the sensor can be activated on any node without having to copy executable files across the cluster.

4.7.1 Issensor

The **Issensor** command displays either a list of sensors, or the list of attributes of sensors. It can be used to display sensors.

With no flags, the **Issensor** list the sensors defined locally, and with the **-a** flags, all sensors defined in the cluster. The **CT_CONTACT** variable indicate where the command will be executed. In Example 4-21, two sensors are defined:

- ▶ NumUsers on node svr02
- ▶ NumLogins on node svr04

Note that with the **-a** flag, the command also indicated the node where each sensor is defined.

Example 4-21 Listing sensors in a cluster

```
# hostname
svr02.itsc.austin.ibm.com
# export CT_CONTACT=svr02
# Issensor
NumUsers1
# Issensor -a
NumLogins {svr04.itsc.austin.ibm.com}
NumUsers1 {svr02.itsc.austin.ibm.com}
# export CT_CONTACT=svr04
# Issensor
NumLogins
```

If you prefer not to modify the **CT_CONTACT** variable, you can use the **-n** flag to specify the nodes on which you look for the defined sensors. In Example 4-22, sensors are defined on all nodes of the cluster, and from the CLI on node svr02, without changing the **CT_CONTACT**; by selecting the nodes with **-n svr04,svr05**, the **Issensor** command filters its result to only list sensors defined on these two nodes.

Example 4-22 Listing remote sensors

```
# echo $CT_CONTACT
svr02
# hostname
svr02.itsc.austin.ibm.com
# Issensor -a
NumUsers2 {svr05.itsc.austin.ibm.com}
NumUsers1 {svr02.itsc.austin.ibm.com}
NumLogins {svr04.itsc.austin.ibm.com}
# Issensor -n svr04,svr05
NumLogins {svr04.itsc.austin.ibm.com}
```

```
NumUsers2 {svr05.itsc.austin.ibm.com}
```

With the `-A` flag and no parameter, or without `-A` but specifying a sensor, `lssensor` returns the list of the sensor attributes, as shown in Example 4-23. The `Command` attribute contains the full path name of the command to execute, while the `RefreshInterval` attribute contains the period at which it is executed. The default is a 60 minutes period.

Example 4-23 Display all sensor attributes

```
# lssensor NumUsers1
Name = NumUsers1
Command = /SharedTools/NumLogins.pl
ConfigChanged = 0
Description =
ErrorExitValue = 1
ExitValue = 255
Float32 = 0
Float64 = 0
Int32 = 0
Int64 = 0
NodeNameList = {svr02.itsc.austin.ibm.com}
RefreshInterval = 60
String =
Uint32 = 0
Uint64 = 0
UserName = rmcuser
# ls -al /SharedTools/NumLogins.pl
-rwxr--r-- 1 root    sys 77 Jun 18 14:06 /SharedTools/NumLogins.pl
```

The `Username` attribute identifies the AIX user ID who created the sensor with `mksensor`. The sensor command (in this example, `/SharedTools/NumLogins.pl`) will be executed in the process environment of the user specified by the `Username` attribute (in this example, `rmcuser`).

Note: Do not confuse the user ID of the creator of the sensor with the user ID that owns the command called by the sensor.

In Example 4-23, if the sensor command `/SharedTools/NumLogins.pl` needs to be started in the environment of the root user to execute correctly (as indicated by the file permission mode), then the `NumUsers1` sensor has to be created by the root user, and not by the `rmcuser`.

4.7.2 mksensor

The **mksensor** command creates a sensor on one node. You cannot create the same sensor on multiple nodes at the same time.

By default, the sensor is created on the node specified by CT_CONTACT, but this can be overridden with the -n flag, as shown in Example 4-24, where the NumUsers1 sensor is started on node svr05 from the node svr02.

Example 4-24 Creating a sensor on a remote node

```
# hostname
svr02.itsc.austin.ibm.com
# echo $CT_CONTACT
svr02
# lssensor -n svr05
# mksensor -n svr05 NumUsers1 "/SharedTools/NumLogins.ksh"
# lssensor -n svr05
NumUsers1 {svr05.itsc.austin.ibm.com}
```

The only option that can be set during the creation of the sensor is the period at which the sensor is executed, using the -i flag followed by an integer representing a time in seconds. Apart from the sensor name, you must specify as the second argument of the **mksensor** command the name of the program you want to execute. You can also specify arguments to this program by surrounding the program name and its arguments with double quotes. For example, you can define the NumUsers1 sensor to run the /SharedTools/NumLogins.pl program every five minutes and pass it the abc argument with the following command:

```
# mksensor -i 300 NumUsers1 "/SharedTools/NumLogins.pl abc"
```

4.7.3 chsensor

The **chsensor** command is used to rename a sensor. You cannot use it to modify the sensor period or the command to be executed. If you need such a change, the only solution is to delete the sensor and recreate it.

Using the -a flag, you can rename a sensor on all nodes in the cluster, or you can restrict the renaming to a set of nodes with the -n flag, followed by the nodes names.

4.7.4 rmsensor

The **rmsensor** command delete sensor on one or several nodes at the same time, using the same -a and -n flags as **chsensor**. You can delete several sensors in one command by passing several sensor names as arguments to **rmsensor**.

Note: There is no concept of active or inactive sensor like there is a concept of active domain. A sensor is active as soon as defined, and you must delete it to deactivate it.

4.8 ERRM commands

The Event Response resource manager handles three types of objects: conditions, responses and associations, as described in Section 2.3.1, “Event Response resource manager (ERRM)” on page 24. It provides you with five groups of commands to act on these objects. Once you know that *condresp* refers to an association, it becomes obvious from the names of the commands to guess their functions:

Display	lcondition , lresponse , and lcondresp
Creation	mkcondition , mkresponse , and mkcondresp
Modification	chcondition and chresponse
Removal	rmcondition , rmresponse , and rmcondresp
Activation	startcondresp and stopcondresp

The monitoring of events using the CLI follows the same principles as when using the GUI:

1. First, define the kind of event you want to monitor.
 - If you are lucky, it corresponds to one of the predefined conditions that are shipped with RSCT, and you can just use it or you can create a slightly different one by copying the predefined condition and changing a few settings.
 - If no predefined condition is close to your needs, there may be resources and attributes in the RMC resource managers that are what you want to monitor. In this case, you have to make your own condition. The **lrsrsrcdef -ad** helps you find which are the dynamic attributes of resources that can be monitored.
 - In the last case, you first have to define a sensor, and the condition that monitors this sensor.
2. Define the response you want the system to exercise when the events occurs. It is made from either the predefined actions or any actions you provide (programs and scripts).
3. Define associations between the conditions you want to monitor and the responses you have chosen.
4. Activate the monitoring of the actions by starting the associations.

Whenever you no longer want to monitor the condition, you can either stop the association if you want to reuse it later, or remove it if you definitely no longer need it.

These steps are a very simplistic view of the event monitoring feature of RMC. The ERRM commands have a rich set of options. In the following sections, we detail some of these options and explain how they can be used in concrete examples.

4.8.1 Location concepts

In a cluster environment, there are many location concepts that must not be confused:

- ▶ The node from where you activate the monitoring of event: this is the node where the actions are executed.
- ▶ The node where the conditions and responses are defined. This is specified in the `-p` flag of the creation commands. To establish an association between a condition and a response, they must be defined on the same node.
- ▶ The node(s) in which events are monitored is specified with the `-m` and `-n` options of the creation commands
- ▶ The node in which is executing the RMC daemon with which commands establish a connection defined by the `CT_CONTACT` variable.
- ▶ The nodes in which resources will be evaluated against the command, defined by the `CT_MANAGEMENT_SCOPE` variable.

For example, it is possible to execute a command on node A to ask the RMC daemon on node B to activate an association of condition/responses on node C, to monitor events occurring on node A, C, and D.

The examples in the following sections detail all these geographical concepts.

4.8.2 `lscondition`

The `lscondition` command can be used to list existing conditions, for example, when you define your event monitoring configuration and search for already available conditions. When you know condition names and pass them as command arguments, `lscondition` reports the status of these conditions.

Definition location

In Example 4-25 on page 128, we look for conditions that are active, using the `-m` flag, which filters only the monitored conditions. All commands are executed on `srv04`, as demonstrated by the result of the `hostname` command. Since

CT_CONTACT is set to svr02, the CLI will forward the request to the RMC daemon on server svr02. When the management scope is defined as local, only conditions listed locally on the node where the RMC daemon is executing are displayed. After changing to a domain wide scope, all conditions defined in the peer domain are listed; in this case, some are defined on svr02 and some on svr04. If the management scope is the full domain, it is still possible to limit the query on one node by specifying the “:node_name” option.

Example 4-25 Effect of CT_MANAGEMENT_SCOPE and :node

```
# hostname
svr04.itsc.austin.ibm.com
# echo $CT_CONTACT
svr02
# export CT_MANAGEMENT_SCOPE=1
#
# lscondition -m
Displaying condition information:
Name           Node           MonitorStatus
"/Peer"        "svr02.itsc.austin.ibm.com" "Monitored"
"/tmp_new"     "svr02.itsc.austin.ibm.com" "Monitored"
"Topas active" "svr02.itsc.austin.ibm.com" "Monitored"
"VMtune active" "svr02.itsc.austin.ibm.com" "Monitored"
#
# export CT_MANAGEMENT_SCOPE=2
# lscondition -m
Displaying condition information:
Name           Node           MonitorStatus
"/Peer"        "svr02.itsc.austin.ibm.com" "Monitored"
"/tmp_new"     "svr02.itsc.austin.ibm.com" "Monitored"
"Topas active" "svr02.itsc.austin.ibm.com" "Monitored"
"VMtune active" "svr02.itsc.austin.ibm.com" "Monitored"
"/tmp space used" "svr04.itsc.austin.ibm.com" "Monitored"
"/Peer"        "svr04.itsc.austin.ibm.com" "Monitored"
"/tmp_new"     "svr04.itsc.austin.ibm.com" "Monitored"
"Check /work04" "svr04.itsc.austin.ibm.com" "Monitored"
#
# lscondition -m :svr02
Displaying condition information:
Name           Node           MonitorStatus
"/Peer"        "svr02.itsc.austin.ibm.com" "Monitored"
"/tmp_new"     "svr02.itsc.austin.ibm.com" "Monitored"
"Topas active" "svr02.itsc.austin.ibm.com" "Monitored"
"VMtune active" "svr02.itsc.austin.ibm.com" "Monitored"
```

Substring match

If one or more character string(s) are passed as an argument to **lscndition**, it will execute a substring match between the command names and the string argument.

Note: The comparison is a substring match, not a full string match.

In Example 4-26, two conditions, `/tmp_new` and `Copy of /tmp_new`, are defined on server `svr02`. The argument of **lscndition** is `/tmp_new:svr02`, where `:svr02` indicates that only conditions defined on `svr02` are to be listed. Because the string `/tmp_new` is included in the both `/tmp_new` and `Copy of /tmp_new` condition names, both are listed in the result of the command.

Example 4-26 Impact of substring match

```
# lscndition /tmp_new:svr02
```

```
Displaying condition information:
```

```
condition 1:
```

```
    Name           = "/tmp_new"
    Node            = "svr02.itsc.austin.ibm.com"
    MonitorStatus   = "Monitored"
    ResourceClass   = "IBM.FileSystem"
    EventExpression = "PercentTotUsed > 90"
    EventDescription = "An event will be generated when >90% of the space
in /tmp
is in use."
    RearmExpression = "PercentTotUsed < 85"
    RearmDescription = "The event will be rearmed when <85% of the space in
/tmp is
in use."
    SelectionString = "Name == \"/tmp\"
    Severity        = "i"
    NodeNames       = {"svr04","svr02","svr05"}
    MgtScope        = "p"
```

```
condition 2:
```

```
    Name           = "Copy of /tmp_new"
    Node            = "svr02.itsc.austin.ibm.com"
    MonitorStatus   = "Not monitored"
    ResourceClass   = "IBM.FileSystem"
    EventExpression = "PercentTotUsed > 90"
... many lines erased here ...
```

Note: Do not use condition names that are substrings of other condition names.

It is not possible to suppress this substring match behavior of **lscndition**. If you want to list a condition using the exact full name match (for example, in a script),

you can work around this behavior using the `lsrsrc` command rather than `lscondition`. However, be aware that the result has slightly different formatting, as shown in Example 4-27 (compare the attribute values such as Severity, ManagementScope and MgtScope, and so on).

Example 4-27 lsrsrc versus lscondition

```
# lsrsrc -s 'Name =? "/tmp_new"' IBM.Condition
Resource Persistent Attributes for: IBM.Condition
resource 1:
    Name                = "/tmp_new"
    ResourceClass       = "IBM.FileSystem"
    DynamicAttribute    = "PercentTotUsed"
    EventExpression     = "PercentTotUsed > 90"
    EventDescription    = "An event will be generated when >90% of the space
in /tmp is in use."
    RearmExpression     = "PercentTotUsed < 85"
    RearmDescription    = "The event will be rearmed when <85% of the space
in /tmp is in use."
    SelectionString     = 'Name == "/tmp"'
    ImmediateEvaluate   = 0
    Severity            = 0
    NodeNames           = {"svr04","svr02","svr05"}
    ManagementScope    = 2
    NodeNameList       = {"svr02.itsc.austin.ibm.com"}
# lscondition /tmp_new:svr02
Displaying condition information:

condition 1:
    Name                = "/tmp_new"
    Node                = "svr02.itsc.austin.ibm.com"
    MonitorStatus       = "Not monitored"
    ResourceClass       = "IBM.FileSystem"
    EventExpression     = "PercentTotUsed > 90"
    EventDescription    = "An event will be generated when >90% of the space
in /tmp is in use."
    RearmExpression     = "PercentTotUsed < 85"
    RearmDescription    = "The event will be rearmed when <85% of the space in
/tmp is in use."
    SelectionString     = "Name == \"\/tmp\""
    Severity            = "i"
    NodeNames           = {"svr04","svr02","svr05"}
    MgtScope            = "p"

condition 2:
    Name                = "Copy of /tmp_new"
    Node                = "svr02.itsc.austin.ibm.com"
... many lines erased here ...
```

Details of lscncondition result

Example 4-28 shows the details of the attributes of two conditions defined in our test environment. Both conditions monitor the execution of a program: **vmstat** or **topas**. The Node attribute indicates that both conditions are defined on svr02 in the cluster. The MonitorStatus attribute shows that vmstat monitoring is not activated while topas is monitored. The MgtScope attribute describes where the events are monitored. This example takes place in a peer domain cluster, and the “p” value for vmstat shows that the response is to be executed if the condition is satisfied on any node of the cluster. For topas, the NodeNames attributes restrict the monitoring to only the svr02 and svr04 nodes within the cluster.

Example 4-28 Conditions attributes

```
# lscncondition "vmstat active"
Displaying condition information:

condition 1:
    Name           = "vmstat active"
    Node           = "svr02.itsc.austin.ibm.com"
    MonitorStatus  = "Not monitored"
    ResourceClass  = "IBM.Program"
    EventExpression = "Processes.CurPidCount >= 1"
    EventDescription = ""
    RearmExpression = "Processes.CurPidCount = 0"
    RearmDescription = ""
    SelectionString = "ProgramName == \"vmstat\""
    Severity       = "i"
    NodeNames      = {}
    MgtScope      = "p"
# lscncondition "Topas active"
Displaying condition information:

condition 1:
    Name           = "Topas active"
    Node           = "svr02.itsc.austin.ibm.com"
    MonitorStatus  = "Monitored"
    ResourceClass  = "IBM.Program"
    EventExpression = "Processes.CurPidCount >= 1"
    EventDescription = ""
    RearmExpression = "Processes.CurPidCount = 0"
    RearmDescription = ""
    SelectionString = "ProgramName == \"topas\""
    Severity       = "i"
    NodeNames    = {"svr02.itsc.austin.ibm.com","svr04.itsc.austin.ibm.com"}
    MgtScope      = "p"
```

Using `lscondition` to create new conditions

Creating a condition manually, by typing all its flags and arguments, may result in a very long command, and it is prone to error. If an existing condition in your environment is similar to the condition you want to create, the `-C` option of `lscondition` can help you: applied to an existing condition (or several ones), it generates the command (`mkcondition`) that would create the same condition.

In Example 4-29, the output of `lscondition -C` is redirected to a temporary file. This file contains the `mkcondition` command necessary to create the “vmstat active” condition. For example, you only need to edit the file, replacing the `\`vmstat\`` string with `\`smitty\``, and changing the condition name “vmstat active” to “smitty monitor” to create a condition to monitor the use of `smitty` on the same set of nodes in your cluster.

Example 4-29 Generating a condition creation file

```
# lscondition -C "vmstat active" > /tmp/mk_vmstat_condition
# cat /tmp/mk_vmstat_condition
Sample mkcondition command for condition "vmstat active":
mkcondition -r "IBM.Program" -e "Processes.CurPidCount >= 1" -E
"Processes.CurPidCount = 0" -d "Generate an event when one vmstat process is
created" -D "Generate an event when no vmstat process are active" -s
"ProgramName == \`vmstat\`" -S "i" -m "p" "vmstat active"
```

4.8.3 `lsresponse`

The `lsresponse` command is the counterpart for responses of `lscondition`. It has two functions:

- ▶ List responses defined in the cluster or on some of its nodes.
- ▶ Display details about the responses passed as arguments.

The `lsresponse` command presents similarities with `lscondition`:

Definition location A response is defined on one node of a cluster.

Substring match When a character string is passed as argument, it will be compared to the name of all existing responses for a substring match, so that all responses whose name contain this substring will be listed.

-C option This option will yield the `mkresponse` commands that could be used to create the same response and each of its actions.

Details of lsresponse result

A response can be seen as a wrapper around several actions that should be performed when an event occurs. The output of **lsresponse** is therefore a series of paragraphs, each of which relates to one of the actions. In Example 4-30, the “Broadcast event all time” response is defined on server svr02, and consists of two actions: “BroadMsg” and “TouchLog”.

The DaysOfWeek and TimeOfDay attributes define the time frame in which the actions can be executed. In this case, it is the same time frame (at all time, and on each day of the week) for both actions, and if an event occurs within this time frame, both actions are executed.

The action script contains the absolute path of the command to execute (see the ActionScript field). The “BroadMsg” action uses one of the predefined actions, while the “TouchLog” action refers to the customer defined script /SharedTools/WhereamI¹⁹.

Example 4-30 Sample response containing two actions

```
# lsresponse "Broadcast event all time":svr02
Displaying response information:

    ResponseName = "Broadcast event all time"
    Node         = "svr02.itsc.austin.ibm.com"
    Action       = "BroadMsg"
    DaysOfWeek   = 1-7
    TimeOfDay    = 0000-2400
    ActionScript = "/usr/sbin/rsct/bin/wallevent"
    ReturnCode   = 0
    CheckReturnCode = "n"
    EventType    = "a"
    StandardOut  = "n"
    EnvironmentVars = ""
    UndefRes     = "n"

    ResponseName = "Broadcast event all time"
    Node         = "svr02.itsc.austin.ibm.com"
    Action       = "TouchLog"
    DaysOfWeek   = 1-7
    TimeOfDay    = 0000-2400
    ActionScript = "/SharedTools/WhereamI"
    ReturnCode   = 1
    CheckReturnCode = "y"
    EventType    = "b"
    StandardOut  = "n"
    EnvironmentVars = ""
```

¹⁹ This script is stored in the shared NFS file system in our test environment.

UndefRes = "n"

The EventType indicates whether this action is to be triggered by the condition event, rearm event, or both. In this example, "BroadMsg" is executed when the event occurs only, while "TouchLog" is triggered by both the event and the rearm events of the condition that is associated with the response.

Response actions are executed in the background by daemons, and hence have no results directly visible by the system administrator who activates them. By default, an entry is appended to the audit log (see Section 4.9, "Audit Log commands" on page 142) for each triggered action, indicating the return code of the action. By setting ReturnCode and CheckReturnCode, you can ask for the audit log to contain extra information. The return code of the action is checked against ReturnCode and a message in the log indicates whether it is the expected result. The highlighted text in Example 4-31 shows difference between the log entries for two actions, one with the attribute ReturnCode set to "y" and the other with the attribute set to "n".

Example 4-31 Difference in audit log entries, with and without setting ReturnCode

```
06/11/02 11:47:14      ERRM Error      Event from VMTune active that occurred at
06/11/02 11:14:09 783476 caused /SharedTools/WhereamI from Broadcast event all
time to complete with a return code of 0 which does not match with the expected
return code 1.
06/11/02 11:47:14      ERRM Info      Event from VMTune active that occurred at
06/11/02 11:14:09 783476 caused /usr/sbin/rsct/bin/wallevent from Broadcast
event all time to complete with a return code of 0.
```

The StandardOut element of an action is useful when debugging new actions. When set to "y", the standard output of the action is redirected to the audit log. The standard error from an action is always redirected to the AuditLog without any configuration.

4.8.4 Iscondresp

The **Iscondresp** command is provided in order to display associations of conditions and responses, and has the same display functions as **Iscondition** or **Isresponse** for conditions and responses. It has two functions:

- ▶ List associations defined in the cluster or on some of its nodes, when it is called without arguments.
- ▶ Display details about the associations as specified command line arguments.

As for the other Event Response resource manager display commands, **Iscondresp** uses substring patterns matching when comparing its arguments with conditions or response names. By default, the argument character string is

compared with the names of existing conditions. With the `-r` flags, the arguments are compared with response names.

In Example 4-32, we use the `-a` flag to restrict the display to active associations (these currently monitored). The first command lists the only defined association containing the string *Topas* in the condition name. The second commands, using the `-r` flag, returns the description of the two associations that contains the string “time” in the name of the response. In this example, two conditions, “Topas active” and “VMtune active”, are associated with the same “Broadcast event all time” response.

Example 4-32 Search by condition or response names

```
# lscondresp -a Topas
```

```
Displaying condition with response information:
```

```
condition-response link 1:
```

```
Condition = "Topas active"  
Response  = "Broadcast event all time"  
Node      = "svr02.itsc.austin.ibm.com"  
State     = "Active"
```

```
# lscondresp -a -r time
```

```
Displaying condition with response information:
```

```
condition-response link 1:
```

```
Condition = "Topas active"  
Response  = "Broadcast event all time"  
Node      = "svr02.itsc.austin.ibm.com"  
State     = "Active"
```

```
condition-response link 2:
```

```
Condition = "VMtune active"  
Response  = "Broadcast event all time"  
Node      = "svr02.itsc.austin.ibm.com"  
State     = "Active"
```

4.8.5 mkcondition

There are two ways to define new conditions with `mkcondition`:

From scratch You then have to specify all attributes of the condition, such as the node on which it will be defined, the event and optional rearm event to monitor, the domain to which the condition applies, and so on.

By copy You specify the `-c` flag, followed by the name of an existing condition, and you only need to provide the attributes you want to be different from the original condition. It is possible to copy

conditions from other nodes, so you do not need to manually define the same condition on different nodes from scratch.

A condition is defined against a resource class. To restrict the condition to a subset of this class resources, you need to specify a selection string with the `-s` flag. As in Example 4-33, the most usual selection is to specify the name of the resource to which you want to apply the condition; in this case, only the `/tmp` file system is monitored to take an action when it becomes more than 90 percent full.

Example 4-33 Restricting the scope of an condition

```
# mkcondition -r "IBM.FileSystem" \  
-e "PercentTotUsed > 90" \  
-s "Name == \"/tmp\" " /tmp space used"
```

You also need to define an event expression which determines when an event will be generated. This expression must contain one dynamic attribute of the monitored class, comparison operands, and constants.

Note: The current version of RMC only supports one attribute in the event expression; you cannot, at this time, monitor two or more attributes within the same expression.

The dynamic attribute can appear several times in the expression, and can be followed by the string “@P”, which refers to the value of the attribute at the previous observation. In Example 4-34, the first occurrence of `mkcondition` contains an event expression using twice the `NumUsers` attribute. The second occurrence defines a simple condition. In the third occurrence of `mkcondition`, we use a combination of the event expressions that were perfectly valid by themselves, and this results in an error, since the combination is an expression with two different dynamic attributes. Note that the error message may be confusing; `PctTotalTimeIdle` is a valid variable name, but it just is not allowed to appear in this place.

Example 4-34 Samples event expressions

```
# mkcondition -r IBM.Host -e "NumUsers != NumUsers@P" UserNumberChanged  
# mkcondition -r IBM.Host -e "(PctTotalTimeIdle < 50)" SimpleTest  
# mkcondition -r IBM.Host -e "(NumUsers != NumUsers@P) && (PctTotalTimeIdle < 50)" DualTest  
2636-063 RMC Error: 2641-005 The variable name "PctTotalTimeIdle" is not recognized.
```

You can, optionally, define a rearm expression for the condition with the `-E` flag. This rearm expression must contain the same dynamic attribute as the event expression. Using a different dynamic attribute results in an error message, as

shown in Example 4-35, where the first command is correct while the second is invalid.

Example 4-35 Attributes used in event and rearm expressions

```
# mkcondition -r IBM.Host -e "NumUsers >= 10" -E "NumUsers < 10" TooManyUsers
# mkcondition -r IBM.Host -e "(NumUsers >= 10)" -E "(PctTotalTimeIdle < 50)" DualTest
2636-063 RMC Error: 2610-341 An expression and its associated re-arm expression specify
different dynamic attribute names: NumUsers and PctTotalTimeIdle.
```

4.8.6 mkresponse

Once you have defined a condition to monitor, you have to choose the response that will be executed when the condition is satisfied. RMC comes with seven predefined responses, which call three predefined scripts. If none of the predefined response matches your needs, you need to create one using **mkresponse**. As with **mkcondition**, you can either create it from scratch or copy an existing condition (with the **-c** flag). However, when copying, you cannot pass modified parameters. You must later use **chresponse** to modify the copied response.

A response consists of one or several actions. **mkresponse** only supports the specification of one action. To define a response with several actions, you use **mkresponse** for the creation of the response and its first action, and you then add the other actions, one at a time, with **chresponse**.

Please refer to Section 4.8.3, “lsresponse” on page 132, which already presented the various parameters that can be specified to **mkresponse**.

The **-s** flag specifies the full path name of the program that will be executed, either when the event expression or the rearm expression of the associated condition is triggered. This program can be a binary executable file, or a script file.

If you write your own script, you may find it useful to read the `logevent`, `notifievent`, and `wallevent` scripts, which are located in `/usr/sbin/rsct/bin`.

It is executed in the process environment of the root user. If this environment is not sufficient to execute the command, you can specify the **-E** flag followed by several variable settings, such as `PATH`.

Note: If you monitor a sensor, please note that the sensor command is executed in the environment of the user ID who created the sensor, while the response is executed in the root user environment. Refer to Section 4.7.1, “lssensor” on page 123 for explanation of the process environment of the sensor command execution.

In addition to the user defined environment variables, a few others are set by RMC before the action is executed. The name of all these variables starts with `ERRM_`.

Example 4-36 shows how a user defined script can take advantage of these variables. The “Broadcast event all time” response contain the `/SharedTools/ShowEnvironment` user-defined action. This action is a simple script that writes to a file, `/tmp/RMC_Variables.out`, the values of some RMC defined environment variables. If the expression “`NumUsers != NumUsers@P`” is evaluated as true on `svr02`, then it triggers the defined action on `svr02`.

Example 4-36 Using RMC defined variable in a user defined action

```
# lresponse "Broadcast event all time":svr02
Displaying response information:
ResponseName   = "Broadcast event all time"
Node           = "svr02.itsc.austin.ibm.com"
Action         = "ListVariable"
DaysOfWeek     = 1-7
TimeOfDay      = 0000-2400
ActionScript   = "/SharedTools/ShowEnvironment"
ReturnCode     = 0
CheckReturnCode = "n"
EventType      = "b"
StandardOut    = "n"
EnvironmentVars = ""
UndefRes       = "n"

# hostname
svr02.itsc.austin.ibm.com
# cat /SharedTools/ShowEnvironment
#!/bin/ksh
echo "ERRM_EXP: "$ERRM_EXPR > /tmp/RMC_Variables.out
echo "ERRM_NODE_NAME: " $ERRM_NODE_NAME >> /tmp/RMC_Variables.out
echo "ERRM_RSRC_CLASS_PNAME: "$ERRM_RSRC_CLASS_PNAME >> /tmp/RMC_Variables.out
echo "ERRM_RSRC_NAME: "$ERRM_RSRC_NAME >> /tmp/RMC_Variables.out
echo "ERRM_VALUE: "$ERRM_VALUE >> /tmp/RMC_Variables.out
```

Once the event has occurred on svr02, then the file /tmp/RMC_Variables.out is generated on svr02, as shown in the following example:

```
# hostname
svr02.itsc.austin.ibm.com
# cat /tmp/RMC_Variables.out
ERRM_EXP: NumUsers != NumUsers@P
ERRM_NODE_NAME: svr02.itsc.austin.ibm.com
ERRM_RSRC_CLASS_PNAME: IBM.Host
ERRM_RSRC_NAME: svr02.itsc.austin.ibm.com
ERRM_VALUE: 6
```

The `ERRM_VALUE` variable contains the value of the dynamic attribute that specified in the event. In this example, there were six users logged in the system.

4.8.7 `mkcondresp/startcondresp`

After both conditions and responses are defined, you must define an association between a condition and one response, and activate this association to start monitoring the condition events. This can be in one or two steps. The `mkcondresp` command defines an association without activating it. You then need to activate it with `startcondresp`. Or you can use `startcondresp` to both define and start the associations.

Both commands can be used to create or activate associations between one condition and several responses. The conditions and responses must all be defined on the same node.

4.8.8 `chcondition`

Once a condition has been created, it can be modified with the `chcondition` command. This modification is dynamic and can be applied while a condition is currently monitored.

The `chcondition` command has the same set of flags as `mkcondition`, all parameters that can be set with `mkcondition` can be modified with `chcondition`.

One extra flag `-c` allows you to rename the condition. In Example 4-37 on page 140, we have the “VMtune active” condition which monitors the `vmstat` program execution. Its name is not well chosen and we rename it with `chcondition -c`. As a result, there is no longer “VMtune active” condition defined in the cluster, the new “VMstat Active” is monitored, as was “VMtune active” before renaming, and the associations previously defined for “VMtune active” now refer to “VMstat Active”.

Example 4-37 Renaming conditions

```
# lsccondition VMtune
```

```
Displaying condition information:
```

```
condition 1:
    Name           = "VMtune active"
    Node           = "svr02.itsc.austin.ibm.com"
    MonitorStatus  = "Monitored"
    ResourceClass  = "IBM.Program"
... many lines erased here ...
    NodeNames      = {}
    MgtScope       = "p"
# chcondition -c "VMstat Active" "VMtune active"
# lsccondition VMtune
lsccondition: 2618-021 The condition "VMtune" was not found.
```

```
# lsccondition "VMstat Active"
```

```
Displaying condition information:
```

```
condition 1:
    Name           = "VMstat Active"
    Node           = "svr02.itsc.austin.ibm.com"
    MonitorStatus  = "Monitored"
    ResourceClass  = "IBM.Program"
... many lines erased here ...
    MgtScope       = "p"
```

```
# lscondresp -a
```

```
Displaying condition with response information:
```

Condition	Response	Node	State
"Topas active"	"Broadcast event all time"	"svr02.itsc.austin.ibm.com"	"Active"
"VMstat Active"	"Broadcast event all time"	"svr02.itsc.austin.ibm.com"	"Active"
"TransmitChanged"	"Broadcast event all time"	"svr02.itsc.austin.ibm.com"	"Active"
"VMstat Active"	"Informational notifications"	"svr02.itsc.austin.ibm.com"	"Active"
"/Peer"	"Critical notifications"	"svr04.itsc.austin.ibm.com"	"Active"
"/tmp space used"	"Informational notifications"	"svr04.itsc.austin.ibm.com"	"Active"

Besides renaming, another possible use of **chcondition** is to modify the set of nodes where the conditions are monitored. For example, when you define a condition, you can use a local management scope to test it on one node, and once the tests are completed, you change the **MgtScope** and **NodeNames** attributes to broaden the scope to the full cluster or a subset of it, using the **-m** and **-n** flags of **chcondition**.

4.8.9 chresponse

A response consists of several possible actions, and **mkresponse** only defines, at most, one action. To add or delete actions in a response, use **chresponse** with the **-a** or **-p** flags, respectively.

When adding an action, you can define the same attributes as when creating the initial action, using the same flags as those of **mkresponse** for **chresponse**, except **-p**. This flag, for **mkresponse**, is used to specify the target node where an response is defined, while it specifies deleting an action for **chresponse**.

You can also rename a response with **chresponse -c**.

Like **chcondition**, **chresponse** is dynamic and can be applied to responses used in active associations.

It is currently not possible to modify an action within a response. For example, if you have defined an action to be valid from 8 a.m. to 6 p.m., Monday to Friday, and you now want to change this time period, you need to delete the action from the response with **chresponse -p**, and recreate it with **chresponse -a** and the new time frame values.

4.8.10 stopcondresp/rmcondresp

Once you no longer need the system to react to a condition event, you use **stopcondresp** to deactivate the association. This leaves the association defined on the system for future use. If you do not expect to reuse it, you can, at the same time, stop monitoring and delete the association with **rmcondresp**.

You can stop monitoring several associations with one command, but they must all relate to the same condition.

4.8.11 rmcondition/rmresponse

When condition and response are no longer needed, you can delete them respectively with **rmcondition** and **rmresponse**. If applied to conditions or responses used in active associations, the commands will return an error unless you specify the **-f** flag.

Example 4-38 Forcing deletion of a monitored condition

```
# rmcondition "VMstat active"  
rmcondition: 2618-062 The condition "VMstat active" is linked to one or more  
responses and cannot be removed.  
# rmcondition -f "VMstat active"
```

4.9 Audit Log commands

The Audit Log resource manager provides a facility for subsystems to record information about their normal operation or errors and failures. Each subsystem that takes advantage of this facility instantiates an audit log resource. It can then add records in this log. At the time of writing this redbook, only the ERRM subsystem is using the audit log facility, as shown in the following example:

```
# lsrsrc -ap IBM.AuditLog
Resource Persistent Attributes for: IBM.AuditLog
resource 1:
    Name = "ERRM"
    MessageCatalog = "IBM.ERrm.cat"
    MessageSet = 1
    DescriptionId = 38
    DescriptionText = "This subsystem is defined by ERRM for recording
significant event information."
    RetentionPeriod = 0
    MaxSize = 1
    SubsystemId = 0
    NodeNameList = {"svr02.itsc.austin.ibm.com"}
```

The `RetentionPeriod` and `MaxSize` attributes provide a mechanism to prevent an infinite growth of the log. The `RetentionPeriod` attribute contains an integer that defines, in days, the duration for which records are kept in the audit log. The `MaxSize` attribute defines the maximum size of the log file in MB. When new records make the log grow above this limit, the oldest records are discarded until the size falls below the limits.

The audit log is stored in the `/var/ct/IW/run/mc/IBM.AuditRM` directory.

Note: If you increase the `MaxSize` attribute, do not forget to verify that the size of the file system containing the log (by default `/var`) is large enough to hold it. It is a good idea to monitor the usage space of the `/var` directory

There are only two commands available to access the audit log records: you can display records with `lsaudrec`, or delete them with `rmaudrec`.

The `-l` flag of `lsaudrec` instructs the command to display standard out and standard error (if they were captured) and can produce a long output. This is especially useful when you have created your own action and asked that, when executed, the result of the action be written in the log (standard out redirection). Example 4-39 on page 143 shows the difference between the display of the same record, with and without the `-l` flag.

Example 4-39 Impact of -l flag

```
# lsaudrec -l -s "Time > #-000001"
Time           = 06/13/02 15:18:35 775848
Subsystem      = ERRM
Category       = Error
Description    = Event from VMstat Active that occurred at 06/13/02 15:18:34
955814 caused /SharedTools/WhereamI from Broadcast Event All Time to complete
with a return code of 0 which does not match with the expected return code 1.
Standard Output = svr02.itsc.austin.ibm.com
                hello world

# lsaudrec -s "Time > #-000001"
Time           Subsystem Category Description
006/13/02 15:18:35      ERRM Info      Event from VMstat Active that occurred at
06/13/02 15:18:34 955814 caused /SharedTools/ShowEnvironment from Broadcast
Event All Time to complete with a return code of 0.
```

Because the audit log is most likely to contain a very large number of records, both `lsaudrec` and `rmaudrec` support a selection mechanism to filter a subset of these records. The easiest selection is based on the time of creation of the record. For example, you can select all records created on June 13th, between 15:18 and 15:19, using the following command:

```
# lsaudrec -s "Time > #06131518 && Time < #06131519"
```

4.10 Additional security configuration

The security concept of RMC consists of two different parts: authentication and authorization. Authentication is the process of ensuring that the client of RMC is really who she/he is claiming to be. Once the client is authenticated, authorization is the process that verifies that this client has the right to perform the requested action.

4.10.1 Authorization

RMC implements authorization using an Access Control List (ACL) file. Each time a client uses a command, the RMC subsystem will retrieve from this ACL file, if the user has been authorized for such an action.

RSCT Resource Monitoring and Control provides a default configuration file, `/usr/sbin/rsct/cfg/ctrmc.acls`. The default ACL file gives:

- ▶ Full privilege to the root user on the local system.
- ▶ Read access to all resources for other users defined locally on the same system.

- ▶ No access to users defined on other systems.

You are likely to need a different set of authorizations in your environment, for example, to give your system administrators IDs the right to create conditions and responses, you will need to modify the ACL file. However, you must *not* modify `/usr/sbin/rsct/cfg/ctrmc.acls`. You have to copy it to `/var/ct/cfg/ctrmc.acls` and make your modifications in this copy. Once done, you need to have the RMC daemon reread the ACLs by refreshing the subsystem with `refresh -s ctrmc`.

If you are working in a cluster environment, the cluster configuration commands automatically create this copy, and customize it. In a peer domain, the default is to give root on any node of the cluster full privileges on any class and resource in the whole cluster. Configuration of a peer domain does not remove access for local users on the cluster nodes.

If you are in a peer domain cluster, and you want to grant the same authorizations on all nodes, you need to update the ACL file and refresh the RMC daemon on each node. But in this case, you do not have to manually edit the file on each node. The content of the file will be independent from any node, so you can maintain the file on one node, and copy it to all other nodes.

The format of the ACL file is detailed in Chapter 3 of the *IBM RSCT for AIX: Guide and Reference*, SA22-7889.

The access control granularity is on a per resource class basis. The ACL file contains one stanza for each class. Within the class, you can grant access to individual users, all users on a host, or all users on any host. The access is granted to the class itself or to all resources in the class. Access right are read (r) or write (w).

If you decide to grant privileges to a user to execute an RMC command, please refer to Chapters 9 and 10 in the *IBM RSCT for AIX: Technical Reference*, SA22-7890. The security section indicates which access rights for which resource class must be given.

As a general rule of thumb, a user needs read privilege to display information (with the `ls...` commands) and write privilege to create, modify, or delete resources (with the `mk...`, `ch...`, and `rm...` commands).

For the following examples, we have created an AIX user (`rmcuser`) on node `svr01`, and all commands and files are local to this node. The `rmcuser` user has no specific rights, and we will grant it several privileges.

First, we want to allow it to create conditions. We have modified the `/var/ct/cfg/ctrmc.acls` file and inserted a stanza for the `IBM.Condition` resource class, as shown in Example 4-40 on page 145.

Example 4-40 Condition access rights

```
IBM.Condition
  rmcuser@LOCALHOST      C rw
  rmcuser@LOCALHOST      R r
  LOCALHOST               * r
  *                       *
```

The last line prevents any user from another host to access the conditions. The LOCALHOST statement in the fourth line allows all users logged on svr01 to display information about conditions defined on svr01.

The second line containing rmcuser grants it the right to read and write the IBM.Condition class, and therefore to create new conditions, or to remove already defined conditions. The third line containing rmcuser grants it only the read right to the IBM.Condition resources, so it can list information about the existing conditions, but it prevents the user from changing an existing condition.

There is no line specific to the root user in this IBM.Condition stanza. Therefore, the root user only has the rights corresponding to the line containing LOCALHOST, which is read only.

Note: Because the access rights are resource class-wide and there is no concept of condition ownership, if you grant a user the privilege to create conditions, the user is also able to delete any condition, including the predefined one, and the conditions defined by other users.

Now that rmcuser can create conditions, we give it the right to create responses, by adding the lines listed in Example 4-41 to the ACL file.

Example 4-41 Responses access rights

```
IBM.EventResponse
  root@LOCALHOST          * rw
  rmcuser@LOCALHOST       C rw
  rmcuser@LOCALHOST       R r
  LOCALHOST               C r
  LOCALHOST               R r
  *                       *
```

These lines give all rights to root about responses, give rights to rmcuser to create or delete responses but not to modify them, and only give to other local users, the possibility to list information about existing responses.

Note: You need the right to modify a response to add actions. The example above would prevent rmcuser from creating responses containing multiple actions.

The rmcuser now needs to activate monitoring of the conditions he has defined. We give it the access rights to the association class by adding lines to the ACL files, as shown in Example 4-42.

Example 4-42 Association access rights

```
IBM.Association
  root@LOCALHOST      * rw
  rmcuser@LOCALHOST   * rw
  LOCALHOST            * r
  *                    *
```

The rw rights to the IBM.Association class gives the right to rmcuser to create and delete associations, as well as to stop and start their monitoring activity.

In Example 4-43, we propose a more secure configuration. We assume that two users exist on the system: we give user rmcadmin all rights to create conditions, responses, and associations, while we only allow rmcuser to create conditions and associate them with responses defined by rmcadmin, in order to prevent rmcuser from writing its own programs and having the system execute them with root privileges.

Important: Remember that actions defined in a response are executed in the process environment of the root user. Therefore, any user who has the right to create a response can have the system execute, on his behalf, any command requiring AIX root privilege.

Example 4-43 Configuration with two user IDs

```
IBM.Condition
  rmcadmin@LOCALHOST  * rw
  rmcuser@LOCALHOST   * rw
  LOCALHOST            * r
  *                    *

IBM.EventResponse
  rmcadmin@LOCALHOST  * rw
  LOCALHOST            * r
  *                    *

IBM.Association
  rmcadmin@LOCALHOST  * rw
  rmcuser@LOCALHOST   * rw
  LOCALHOST            * r
  *                    *
```

4.10.2 Remote node access

You can use RMC commands on one server to manage resources on another server by setting the CT_CONTACT variable, even if both servers are not part of a cluster or a peer domain. For example, if you have to remotely administer AIX systems from another AIX system that may be located on another site (as shown in Figure 4-4), you can use the methods²⁰ explained in the following steps:

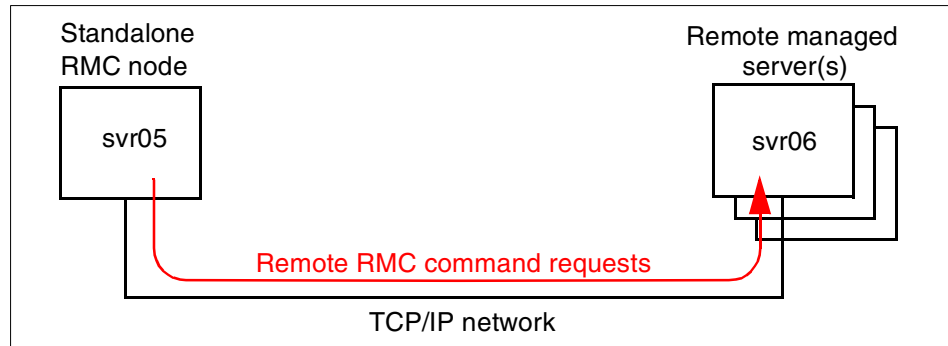

Figure 4-4 Remote management without a cluster configuration

Note: In the following steps, we assume that:

- ▶ The default AIX 5L Version 5.1 installation has been performed on all the servers and no RMC customization has been performed yet.
- ▶ All files are referenced by the default names and location.
- ▶ The root user on server svr05 can be allowed to execute any actions on any RMC class or resources of server svr06.

1. Modify the ACL file on svr06 by adding the highlighted line to the DEFAULT stanza, as shown in the following example:

```
# cat /var/ct/cfg/ctrmc.ac1s
IBM.HostPublic
*          *          r
UNAUTHENT *          r

DEFAULT
root@LOCALHOST      *          rw
root@svr05.itsc.austin.ibm.com *          rw
LOCALHOST          *          r
```

²⁰ You must have a reliable TCP/IP connection between the AIX system that you are currently logged into and the remotely managed systems.

The root user on svr05 is now authorized to execute RMC commands on svr06; however, you still have to configure the authentication mechanism. If you execute some RMC commands from svr05 to svr06, you will receive an error message, as shown in the following example:

```
# echo $CT_CONTACT
svr06
# lsrsrc
lsrsrc: 2612-024 Could not authenticate user.
```

2. Customize the authentication daemon configuration file by copying the sample file `/usr/sbin/rsct/cfg/ctcasd.cfg` in the `/var/ct/cfg` directory. You have to edit the file to set variable values, as highlighted in the following example:

```
# cat /var/ct/cfg/ctcasd.cfg
TRACE= false
TRACEFILE=
TRACELEVELS=
TRACESIZE=
RQUEUE SIZE=
MAXTHREADS=
MINTHREADS=
HBA_USING_SSH_KEYS= false
HBA_PRIVKEYFILE=/var/ct/cfg/ct_has.pkf
HBA_PUBKEYFILE=/var/ct/cfg/ct_has.qkf
HBA_THLFILE=/var/ct/cfg/ct_has.thl
HBA_KEYGEN_METHOD= rsa1024
SERVICES=hba CAS
```

3. Generate the private and public key files on both nodes. These two files, `ct_has.pkf` and `ct_has.qkf`, should be located in the `/var/ct/cfg` directory and be consistent with the variables defined in the previous example.

Note: If these files already exist and are not empty, your server authentication mechanism has already been configured. Do not continue this process.

To create a pair of key files, use the `ctskeygen` command, as shown in the following example:

```
# ctskeygen -n -f -m rsa1024
# ls -l /var/ct/cfgct_ha*
-r--r--r--  1 root  system           145 Jun 24 13:42 ct_has.pkf
-r-----  1 root  system           271 Jun 24 13:42 ct_has.qkf
```

4. Start the authentication subsystem on both nodes.

```
# startsrc -s ctcas
```

5. Dump the public key into a file that will be transferred to the other server on each node. For example, issue the following command on svr06:

```
# ctskeygen -d ctskeygen -d > /tmp/svr06_public.sh
```

6. Edit the generated files to include the **ctsth1** command on both nodes. For example, if the /tmp/svr06_public.sh file on svr06 contains the following content:

```
# cat /tmp/svr06_public.sh
120400c980e236ab459f7a5510180bd854a0b2eb5ace87b646b9b0165ab620f2f0b166848be
cc0eacfe68c5263f48d6dec34d4fd1b84c964fce1d9924a44ab689f46f7030949de4d4e7858
e81456c33bd8f5f74d4492a4d12a82ee435b86d2cec9526805097d46a0bb17094318c423fb1
82d8e089f78d3e39efa72de4aa986f78aa8cf0103
(generation method: rsa1024)
```

then insert the following string in the first line of the file and remove the last line:

```
/usr/sbin/rsct/bin/ctsth1 -a -m rsa1024 -n svr06.itsc.austin.ibm.com -p
```

The edited file should have the following content and it must have only one line:

```
# cat /tmp/svr06_public.sh
/usr/sbin/rsct/bin/ctsth1 -a -m rsa1024 -n svr06.itsc.austin.ibm.com -p
120400c980e236ab459f7a5510180bd854a0b2eb5ace87b646b9b0165ab620f2f0b166848be
cc0eacfe68c5263f48d6dec34d4fd1b84c964fce1d9924a44ab689f46f7030949de4d4e7858
e81456c33bd8f5f74d4492a4d12a82ee435b86d2cec9526805097d46a0bb17094318c423fb1
82d8e089f78d3e39efa72de4aa986f78aa8cf0103
```

7. Transfer the created shell script containing the svr06's public key from svr06 to svr05, and execute it on svr05. Then do the opposite operation. It will add the peer's public key into the trusted host list on the other peer.

The following example shows how to add the svr06's public key to the trusted host list on svr05:

```
# hostname
svr05.itsc.austin.ibm.com
# touch /var/ct/cfg/ct_has.th1
# ksh /tmp/svr06_public.sh
```

Please note if the trusted host list file does not exist on one of the hosts before invoking the shell script, create an empty one using the **touch** command.

Note: When executed on server A, the **ctsth1** command should take the public key of server B as an argument and add it to the trusted host list (/var/ct/cfg/ct_has.th1) on server A.

8. Verify the peer's public key is correctly added to the trusted host list.

The following example shows how to verify if the svr06's public key is correctly added on svr05:

```
# hostname
svr05.itsc.austin.ibm.com
# ctsth1 -l
ctsth1: Contents of trusted host list file:
-----
Host name: svr06.itsc.austin.ibm.com
Identifier Generation Method: rsa1024
Identifier Value:
120400c980e236ab459f7a5510180bd854a0b2eb5ace87b646b9b0165ab620f2f0b166848be
cc0eacfe68c5263f48d6dec34d4fd1b84c964fce1d9924a44ab689f46f7030949de4d4e7858
e81456c33bd8f5f74d4492a4d12a82ee435b86d2cec9526805097d46a0bb17094318c423fb1
82d8e089f78d3e39efa72de4aa986f78aa8cf0103
```

Now you can remotely execute commands from svr05 to svr06 or vice versa. In Example 4-44, the root user on svr05 has set the CT_CONTACT variable to svr06.itsc.austin.ibm.com and issued the **lsrsrc** command to get the description of the IBM.Host resource known by the Host resource manager on svr06.

Example 4-44 Remote command execution

```
# hostname
svr05.itsc.austin.ibm.com
# echo $CT_CONTACT
svr06.itsc.austin.ibm.com
# lsrsrc "IBM.Host"
Resource Persistent Attributes for: IBM.Host
resource 1:
      Name = "svr06.itsc.austin.ibm.com"
      NodeNameList = {"svr06.itsc.austin.ibm.com"}
      NumProcessors = 4
      RealMemSize = 1073639424
      OSName = "AIX"
      KernelVersion = "5.1"
      DistributionName = "IBM"
      DistributionVersion = "5.1"
      Architecture = "ppc"
```



Monitoring applications

You can exploit RMC to monitor applications such as DB2 Universal Database for AIX Version 7.2 (DB2 UDB) and IBM HTTP Server (IHS). In this chapter, we show you several examples on how to monitor these applications using RMC.

This chapter describes the following topics:

- ▶ Section 5.1, “How to monitor DB2 Universal Database” on page 152
- ▶ Section 5.2, “Advanced monitoring” on page 156
- ▶ Section 5.3, “How to send events to Tivoli Enterprise Console” on page 170

Throughout this chapter, we use the RMC command line interface instead of Web-based System Manager to define and monitor applications.

5.1 How to monitor DB2 Universal Database

To keep applications running, the following system resources are generally required:

- ▶ The existence of the application processes.
- ▶ The minimum CPU resources to satisfy the required transaction performance of the application.
- ▶ Sufficient memory resources to be used by application processes, including:
 - Free physical memory pages
 - Shared memory segments
- ▶ Sufficient file system resources to be used by application processes, including:
 - Data files
 - Log files

In this section, we first describe several methods for monitoring DB2 UDB. We also describe how to monitor DB2 UDB using the program resource class (IBM.Program) managed by the host resource manager (see Section 2.3.5, “Host resource manager” on page 28).

As a general point of view, there are many methods for monitoring DB2 UDB, because the method you should use depends on your system and your requirements. Thus, we describe the basic methods for monitoring DB2 UDB here:

- ▶ Monitoring DB2 UDB abnormal activity
DB2 UDB provides several log files, such as db2diag.log, db2alert.log, and so on. You can detect abnormal activity by checking these log files.
- ▶ Monitoring DB2 UDB application resources
DB2 UDB provides several functions for monitoring its application resources, such as the governor, snapshot monitor, event monitor, and so on. You can set threshold values against DB2 UDB resources, such as wasted CPU time, number of locks, and so on, using the governor. You can also monitor table space usage percentage by checking DB2 UDB system tables.
- ▶ Monitoring DB2 UDB processes
In AIX, you can verify whether relevant DB2 UDB processes are running or not by using the `ps` command. For example, you can check if the database server is running, if a DB2 UDB application that is bound to DB2 UDB has an agent assigned to it, and so on.

Although there are several ways to monitor UDB by exploiting RMC, we provide the following examples in this chapter:

- ▶ Monitoring DB2 UDB processes in Section 5.1.2, “Configure a DB2 UDB monitor resource” on page 155.
- ▶ Monitoring DB2 UDB application responses in Section 5.2.2, “Advanced monitoring example” on page 160.

For further information about the DB2 UDB administration, please refer to the *IBM DB2 Universal Database Administration Guide: Performance Version 7*, SC09-2945.

5.1.1 Components to be monitored

You can easily verify if a DB2 UDB instance is running by checking the existence of the relevant DB2 UDB processes. The following list²¹ contains the most vital DB2 UDB processes:

db2sysc	DB2 system controller process
db2gds	Global daemon spawner that spawns new processes
db2ipccm	Local client connection listener process
db2tcpcm	TCP/IP protocol listener process
db2resyn	Resync agent process that scans the global resync list
db2wdog	Watchdog process that handles abnormal terminations

Once you have started DB2 UDB, you can see these processes running (see Example 5-2 on page 154). You might want to know which process should be monitored in order to monitor a DB2 UDB instance. However, just monitoring the db2sysc process is sufficient for our purposes, because DB2 UDB processes keep watching each other, so if one process should be down, all the other processes are also down. This is well-known behavior defined by the DB2 UDB architecture.

For further information about the DB2 UDB process relationship and its architecture, please refer to the *IBM DB2 Universal Database Troubleshooting Guide Version 7*, GC09-2850.

Example 5-1 on page 154 shows DB2 UDB processes using the -ef option of the ps command. You can easily distinguish each process name shown in the last column (CMD).

²¹ This is not a complete list. You may find other processes in your DB2 UDB environment.

Example 5-1 DB2 UDB processes using ps -ef

```
# ps -ef | head -1; ps -ef | grep db2 | grep -v grep
      UID  PID  PPID  C   STIME   TTY  TIME  CMD
db2admin 3740 19822  0 11:18:32   -  0:00 db2srvlst
db2admin 19822 31966  0 11:18:31   -  0:12 db2gds
db2admin 19996 31966  0 11:18:31   -  0:00 db2tcpcm
db2admin 26150 19822  0 11:18:32   -  0:00 db2resyn
db2admin 26482 31966  0 11:18:31   -  0:00 db2ipccm
db2admin 29608 26482  0 11:19:30   -  1:14 db2agent (idle)
db2admin 29846 31966  0 11:18:32   -  0:00 db2spmrm
      root 30550    1  0 11:18:31   -  0:00 db2wdog
db2admin 31382 31966  0 11:18:31   -  0:00 db2tcpcm
db2admin 31966 30550  0 11:18:31   -  0:00 db2sysc
db2admin 33720 19822  0 11:18:32   -  0:00 db2spmlw
```

However, you cannot use the process names shown in the CMD column to monitor a DB2 UDB instance using RMC, because RMC interprets all the process names (for example, db2srvlst and db2gds) as db2sysc, as shown in Example 5-2.

Note: ProgramName identifies the name of the command or program to be monitored. The program name is the base name of the file containing the program. This name is displayed by the `ps` command when `-l` or `-o comm` is specified. The program name displayed by `ps` when `-f` or `-o args` is specified may not be the same as the base name of the file containing the program.

Example 5-2 DB2 UDB processes using ps -elo pid, comm

```
# ps -elo pid,comm | head -1; ps -elo pid,comm | grep db2
      PID COMMAND
3740 db2sysc
19822 db2sysc
19996 db2sysc
26150 db2sysc
26482 db2sysc
29608 db2sysc
29846 db2sysc
30550 db2sysc
31382 db2sysc
31966 db2sysc
33720 db2sysc
```

Therefore, you can only monitor the number of db2sysc process in a DB2 UDB instance using RMC.

5.1.2 Configure a DB2 UDB monitor resource

You can monitor a DB2 UDB instance by simply checking if the `db2sysc` process is running. You can achieve this by specifying a filter option for the `mkcondition` command.

We provide you with a sample to configure a resource class using the `mkcondition` and the `mkcondresp` command.

Example 5-3 shows how to define a condition to monitor a DB2 UDB instance.

Example 5-3 Define a condition to monitor DB2 UDB

```
# mkcondition -r IBM.Program \  
-e 'Processes.CurPidCount <= 0' \  
-E 'Processes.CurPidCount > 0' \  
-d 'An event will be generated whenever the DB2 UDB daemon is not running.' \  
-D 'The event will be rearmed when the DB2 UDB daemon is running.' \  
-s 'ProgramName == "db2sysc" && Filter == "ruser=="db2admin\""' \  
-S c \  
-V 'UDB server state'
```

The `-s` option defines a selection string. In this example, the selection string is defined as the following two conditions:

- ▶ The process name must be `db2sysc`.
- ▶ The real user name must be `db2admin`.

To verify if this condition is defined, issue the `lscondition` command, as shown in the following example:

```
# lscondition "UDB server state"  
Displaying condition information:  
Name                               MonitorStatus  
... many lines are omitted ...  
"DB2 UDB server state"             "Not monitored"
```

To associate this condition with the appropriate response and activate the condition, do the following:

1. Associate a condition with a response:

```
# mkcondresp 'UDB server state' 'E-mail root anytime'
```

2. Start monitoring of the condition and response:

```
# startcondresp 'UDB server state' 'E-mail root anytime'
```

3. List the state of the defined condition and response:

```
# lscondresp  
Displaying condition with response information:
```

Condition	Response	State
"UDB server state"	"E-mail root anytime"	"Active"

If you start and stop this DB2 UDB instance, you will receive the event and the rearm event notification using e-mail, as shown in the following example:

```
From root Wed May 29 11:51:45 2002
Date: Wed, 29 May 2002 11:51:45 +0900
From: root
To: root
Subject: UDB server state
```

=====

Wednesday 05/29/02 11:51:44

```
Condition Name: UDB server state
Severity: Critical
Data Type: Event
Expression: Processes.CurPidCount <= 0
```

```
Resource Name: ProgramName == 'db2sysc' && Filter == 'ruser== db2admin'
Resource Class: Program
Data Type: CT_SD_PTR
Data Value: [0,1,{}},{26896}]
Node Name: f02n13
Node NameList: {f02n13}
Resource Type: 0
```

=====

5.2 Advanced monitoring

In this section, we explore what we can do for advanced monitoring with user defined scripts and the IBM.Sensor resource class. You can also create your own response, which calls your script using the **mkresponse** command. Combining these two, you can have an advanced monitoring method of your application. We explain how this method will work using several examples in this section.

5.2.1 Define your own sensor

IBM.Sensor is a resource class that periodically invokes a user defined script. The result of this script can then be monitored by ERRM. You can implement your own algorithm in the script to monitor your application; however, the script has to use an appropriate format, which the sensor resource manager accepts, to return values.

A simple sensor example to monitor process count

For the first example of the exploitation of the IBM.Sensor resource class, we show a simple sensor resource example that emulates the IBM.Program resource class. You need to create your event sensor command before defining your sensor resource.

Example 5-4 shows an example script placed in /home/rmctest/program.sh.

Example 5-4 The first example of sensor script: program.sh

```
#!/bin/sh
name=$1
proc_cnt=`ps -eo comm | grep '^$name$' | wc -l`
proc_cnt=`expr $n + 0`
echo String="'$name'" Int32=$proc_cnt
exit 0
```

This script checks whether the specified process is running or not. You have to specify the command name of the process to be checked as the first command line argument of the script. The script counts the number of the specified process and reports it in a format acceptable to the sensor resource manager. The following example shows you how the sensor script works:

```
# /home/rmctest/program.sh httpd
String="httpd" Int32=6
# echo $?
0
```

In this example, the script writes the result, which is composed of the following two components, to the standard out stream and returns the return code 0:

String="httpd" The program name of process to be checked
Int32=6 The result value (process counts)

To define a sensor using this script, issue the following command:

```
# /usr/sbin/rsct/bin/mksensor -i 60 httpdcheck '/home/rmctest/program.sh httpd'
```

In this example, the first argument for the **mksensor** command, **-i 60** option, specifies RefreshInterval, and the second argument is a sensor name, **httpcheck**, which you are going to define, and the last is a quoted string that is composed of the absolute path name of the script (event sensor command) and its argument.

To verify if this sensor is defined, issue the **lssensor** command, as shown in the following example:

```
# /usr/sbin/rsct/bin/lssensor
httpdcheck
```

If you see the sensor name `httpdcheck` in the output from the `lssensor` command, then your sensor is defined correctly.

You can specify sensor names as arguments of the `lssensor` command to view the detailed sensor definition, as shown in Example 5-5. In this example, you see the Name and the Command attributes defined as you specified, and also see the String and the Int32 attributes reflecting the expected values.

Example 5-5 Viewing a sensor definition

```
# /usr/sbin/rsct/bin/lssensor httpdcheck
Name = httpdcheck
Command = /home/rmctest/program.sh httpd
ConfigChanged = 0
Description =
ErrorExitValue = 1
ExitValue = 0
Float32 = 0
Float64 = 0
Int32 = 6
Int64 = 0
NodeNameList = {f02n13}
RefreshInterval = 60
String = httpd
Uint32 = 0
Uint64 = 0
UserName = root
```

The sensor resource manager daemon (IBM.SensorRMD) invokes your script in either of the following cases:

- ▶ Every time you issue the `lssensor` command to show the detail information about the sensor.
- ▶ Once for RefreshInterval, 60 seconds by default, after the activation of your sensor.

Define a new condition

The next step is to define an condition, “httpd server state”, to be used with the `httpdcheck` sensor.

As shown in Example 5-6 on page 159, You have to specify the resource class name `IBM.Sensor` with the `-r` flag, and the selection string `Name == “httpdcheck”` with the `-s` flag of `mkcondition`.

The `httpdcheck` sensor script returns the number of monitored process as the `Int32` value, which is stored as an attribute named `Int32`, as shown in Example 5-5. You can refer to this value upon defining the new condition. If you

define the event expression as `Int32 <= 0`, an event will be generated when the `Int32` value is less than or equal to 0, which means that no process is running. The rearm expression is defined as `Int32 > 0`, which means that at least one process is running.

Example 5-6 Defining a new condition using a sensor

```
# mkcondition -r IBM.Sensor \  
-e 'Int32 <= 0' \  
-E 'Int32 > 0' \  
-d 'An event will be generated whenever the httpd does not run.' \  
-D 'The event will be rearmed when the httpd runs.' \  
-s 'Name == "httpdcheck"' \  
-S c \  
'httpd server state'
```

Associate a condition with a response

To associate a new condition with a response, do the following steps:

1. Associate the condition “httpd server state” with the response “E-mail root anytime”:

```
# mkcondresp 'httpd server state' 'E-mail root anytime'
```

2. Start monitoring of the newly associated condition and response:

```
# startcondresp 'httpd server state' 'E-mail root anytime'
```

3. Verify the state of the condition and response:

```
# lscondresp  
Displaying condition with response information:  
Condition          Response          State  
"httpd server state" "E-mail root anytime" "Active"
```

If you start and stop the `httpd` daemon, the root user will receive event and rearm event notification by e-mail, as shown in the following example:

```
From root Sat Jun 1 13:12:30 2002  
Date: Sat, 1 Jun 2002 13:12:30 +0900  
From: root  
To: root  
Subject: httpd server state
```

```
=====
```

```
Saturday 06/01/02 13:12:30
```

```
Condition Name: httpd server state  
Severity: Critical  
Data Type: Event
```

```

Expression: Int32 <= 0

Resource Name: httpdcheck
Resource Class: Sensor
Data Type: CT_INT32
Data Value: 0
Node Name: f02n13
Node NameList: {f02n13}
Resource Type: 0
=====

```

Figure 5-1 illustrates the relationships between the objects we defined in this example.

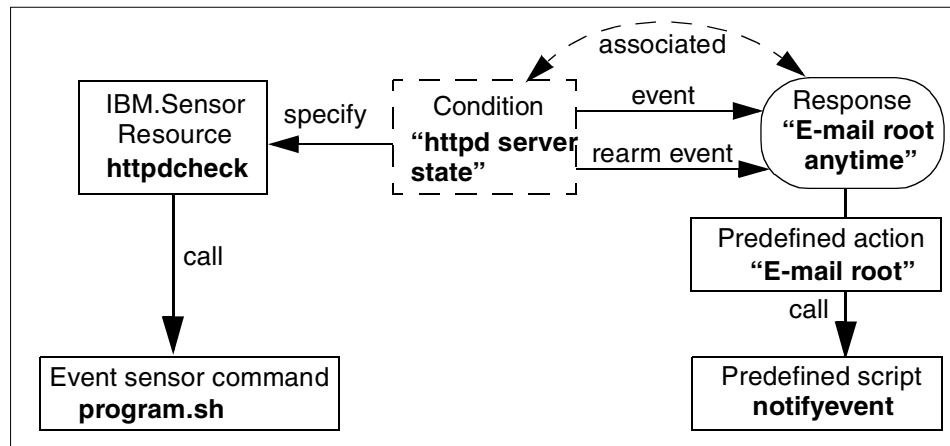

Figure 5-1 Relationship between sensor, response, and others

5.2.2 Advanced monitoring example

The existence of a process does not always assure that the process is working correctly. You might want to verify whether your application is working correctly by accessing the application. For example, you can verify that DB2 UDB is running correctly by issuing a simple query request.

Monitoring responses from DB2 UDB

Example 5-7 shows an sample script that connects to the DB2 UDB instance db2inst1 and selects from syscat.tables, which is predefined in DB2 UDB.

Example 5-7 Monitoring DB2 UDB response: udbcheck.sh

```

#!/bin/sh
DBINSNAME=db2inst1
DBNAME=db2test

```

```

DBLANG=en_US

(
su - $DBINSNAME -c LANG=$DBLANG db2 -t << __EOF__
connect to $DBNAME;
select count(*) from syscat.tables;
terminate;
__EOF__
) 2>&1 | grep -q '^ *[0-9]'
```

```

if [ $? -eq 0 ]; then
    echo 'String="got response"'
else
    echo 'String="no response"'
fi
exit 0
```

Because this script will be invoked in the root user environment, you need to write the script to switch to the user with enough authority to access the target database as well as setting the appropriate environment values.

It is possible that the sensor script hangs or takes too long to complete checking. In that case, monitoring with sensor will also take long time. To specify a long time-out value, you have to explicitly specify a longer timeout value upon creation of the sensor using the `-i` option of `mksensor`.

You might want to have an additional timeout logic for your sensor script. Example 5-8 shows an example Perl script to implement the time-out logic.

Example 5-8 ttimeout.pl

```

#!/usr/bin/perl
use Expect;

$TIMEOUT = shift || 10;

for $i (@ARGV) {
    $cmd .= " $i";
}
$cmd =~ s/^ //;

$e = Expect->spawn($cmd);
&timeout unless ($e->expect($TIMEOUT, "-re", "[A-Za-z0-9]=.*"));
sleep(1);
$e->hard_close();
exit(0);

sub timeout {
```



```
-d 'An event will be generated if UDB server does not respond.' \  
-D 'A rearm event will generated if UDB server become to respond again.' \  
-s 'Name == "udbcheck"' \  
-S c \  
'UDB server response'  
# mkcondresp "UDB server response" "E-mail root anytime"  
# startcondresp "UDB server response" "E-mail root anytime"
```

If the DB2 UDB instance does not respond within the timeout period, the root user will receive an event notification by e-mail, as shown in Example 5-10.

Example 5-10 E-mail message when DB2 UDB responded

```
From root Sun Jun  2 03:34:32 2002  
Date: Sun, 2 Jun 2002 03:34:32 +0900  
From: root  
To: root  
Subject: UDB server response
```

=====

Sunday 06/02/02 03:34:31

```
Condition Name: UDB server response  
Severity: Critical  
Data Type: Rearm event  
Expression: String == "got response"
```

```
Resource Name: udbcheck  
Resource Class: Sensor  
Data Type: CT_CHAR_PTR  
Data Value: got response  
Node Name: f02n13  
Node NameList: {f02n13}  
Resource Type: 0
```

=====

If the DB2 UDB instance does not respond within the timeout period, the root user will receive an event notification by e-mail, as shown in Example 5-11.

Example 5-11 E-mail message when DB2 UDB has not responded

```
From root Sun Jun  2 03:33:46 2002  
Date: Sun, 2 Jun 2002 03:33:46 +0900  
From: root  
To: root  
Subject: UDB server response
```

```
=====  
Sunday 06/02/02 03:33:46  
  
Condition Name: UDB server response  
Severity: Critical  
Data Type: Event  
Expression: String != "got response"  
  
Resource Name: udbcheck  
Resource Class: Sensor  
Data Type: CT_CHAR_PTR  
Data Value: timeout  
Node Name: f02n13  
Node NameList: {f02n13}  
Resource Type: 0  
=====
```

In this example, there are three different values that the sensor resource manager could receive:

- ▶ “got response” from the udbcheck.sh script
- ▶ “no response” from the udbcheck.sh script
- ▶ Timeout from the timeout.pl script

Monitoring responses from IBM HTTP Server

If you want to monitor responses of Web applications, you may want to send a simple HTTP request to the system that is running IBM HTTP Server and verify if you receive an appropriate response. Example 5-12 on page 165 shows you an example script for sending an HTTP request. You need to specify two arguments for the script, as shown in the following:

```
# /home/rmctest/httpdcheck.pl http://server_name/document/for/test.html OK
```

The first argument is the target URL, and the second is the expected string pattern as a response.

You may want to use the script with `timeout.pl`, as shown in the following, in case of long timeout:

```
# /home/rmctest/timeout.pl 10 /home/rmctest/httpdcheck.pl \  
http://server_name/document/for/test.html OK
```

The script is written using Perl and uses the `IO::Socket` package, which is included in the `perl.rte` fileset on AIX 5L Version 5.1. The `IO::Socket` package provides several functions to easily use the remote connection mechanism provided by the TCP/IP socket.

Example 5-12 httpdcheck.pl

```
#!/usr/bin/perl
use IO::Socket;

$url=$ARGV[0];
$pattern=$ARGV[1];

$url =~ /^http:\\\/\([^:\/]+\):([0-9]+)*((\/.*)*)$/;
$host = $1;
if ($3 eq "") {
    $port = 80;
} else {
    $port = $3;
}
if ($4 eq "") {
    $path = "/";
} else {
    $path = $4;
}

$ss = new IO::Socket::INET(PeerAddr => $host
                           , PeerPort => $port
                           , Proto => "tcp");

$res=0;
if ($ss) {
    print $ss "GET $path\r\n";
    while (<$ss>) {
        if ($_ =~ $pattern) {
            $res=1;
        }
    }
} else {
    printf("String=\"connection error\"\n");
    exit(0);
}
if ($res) {
    print "String=\"got response\"\n";
} else {
    print "String=\"bad response\"\n";
}
close($ss);
exit(0);
```

5.2.3 Creating your own response

The **mkresponse** command creates responses that can call scripts defined in actions. RMC provides you with several predefined responses, which would be a good starting point to see how the response works.

If you invoke the **lsresponse** command without flags, it lists all the already defined responses. If you specify response names, then it shows the definition of the specified responses. The following example shows the definition of the predefined response “E-mail root anytime”:

```
# lsresponse 'E-mail root anytime'
Displaying response information:

ResponseName = "E-mail root anytime"
Action      = "E-mail root"
DaysOfWeek   = 1-7
TimeOfDay    = 0000-2400
ActionScript = "/usr/sbin/rsct/bin/notifyscript root"
ReturnCode   = -1
CheckReturnCode = "n"
EventType    = "b"
StandardOut  = "n"
EnvironmentVars = ""
UndefRes     = "n"
```

The “E-mail root anytime” response is associated with the predefined action “E-mail root”, as shown in the Action field. The ActionScript field defines the absolute path name of the **notifyscript** command of the action “E-mail root”. The **notifyscript** will be invoked upon the event or rearm occur defined in the condition.

Example 5-13 excerpts the important part from **notifyscript**.

Example 5-13 Excerpt of notify

```
#!/bin/ksh

.... skip many lines ....

generate_message () {

    cat <<EOF
=====

${EventTime}

${ConditionName}: $ERRM_COND_NAME
${Severity}: $ERRM_COND_SEVERITY
```



```

${EventType}: $ERRM_TYPE
${Expression}: $ERRM_EXPR

${ResourceName}: $ERRM_RSRC_NAME
${ResourceClass}: $ERRM_RSRC_CLASS_NAME
${DataType}: $ERRM_DATA_TYPE
${DataValue}: $ERRM_VALUE
${NodeName}: $ERRM_NODE_NAME
${NodeNameList}: $ERRM_NODE_NAMELIST
${RsrcType}: $ERRM_RSRC_TYPE
EOF

print "======"
}

.... skip many lines ....

generate_message | mail -s "$ERRM_COND_NAME" $mailTo

```

The last line in Example 5-13 on page 166 sends an e-mail with the message body generated by the `generate_message` sub-routine to the e-mail address specified by the `$mailTo` variable. The generated message by the sub-routine places several environment variables in the message body. For example, the line `Data Value: timeout` in Example 5-11 on page 163 informs you that the DB2 UDB server did not respond within the specified timeout value. You can find the following line that generates this message in Example 5-13 on page 166:

```
${DataValue}: $ERRM_VALUE
```

The **notifyevent** script also picks up the *timeout* value from the environment variable `ERRM_VALUE`.

Create your own response

All the predefined responses are designed to send notify events to the operator by some means. In addition to these event notification responses, you might want to automatically recreate a simple problem if RMC detects it. In this case, you must have a well-tested procedure to recreate the problem.

Example 5-14 shows a simple script to recreate the problem where there are no `httpd` process. The shell script saves the core file of `httpd` (if there is one), and starts `httpd`.

Example 5-14 httpdrestart.sh

```

#!/bin/sh
HTTPDCORE='/usr/HTTPServer/core*'

```

```

COREDIR=/home/rmctest/corefiles

if [ -f $HTTPDCORE ]; then
    mv $HTTPDCORE $COREDIR
fi
CORE_NAMING=yes /usr/HTTPServer/bin/apachectl start

```

The `CORE_NAMING`²³ environment variable used in this example instructs the AIX kernel to produce core files using the file name format `core.pid.ddmmss`,²⁴ where:

pid	Process ID
dd	Day of the month
hh	Hours
mm	Minutes
ss	Seconds

The shell script should be called upon the occurrence of the event defined as “no httpd process is running”; however, it should not be called upon the occurrence of the rearm event. To create a new response to call this shell script as an action for the event, do the following:

```

# mkresponse -n httpdrestart -s /home/rmctest/httpdrestart.sh -e a \
  'Restart httpd'

```

The first argument, `-n httpdrestart`, specifies the action name. The second argument, `-s /home/rmctest/httpdrestart.sh`, specifies the action script. The third argument, `-e a`, specifies that the action is only applicable for events. The final argument is a response name.

You can check if the new response is created successfully, as shown in the following example:

```

# lsresponse 'Restart httpd'
Displaying response information:

```

```

ResponseName = "Restart httpd"
Action       = "httpdrestart"
DaysOfWeek   = 1-7
TimeOfDay    = 0000-2400
ActionScript = "/home/rmctest/httpdrestart.sh"
ReturnCode   = 0
CheckReturnCode = "n"
EventType    = "a"

```

²³ The `CORE_NAMING` environment variable is supported from AIX 5L Version 5.1 onwards.

²⁴ The timestamp uses the GMT (Greenwich mean time) time zone.

```
StandardOut    = "n"
EnvironmentVars = ""
UndefRes       = "n"
```

To associate the condition “httpd server state” with the new response “Restart httpd”, do the following:

```
# mkcondresp 'httpd server state' 'Restart httpd'
```

Then start the monitoring:

```
# startcondresp 'httpd server state' 'Restart httpd'
```

To verify if the httpdrestart response works, do the following steps:

1. Start the httpd process manually:

```
# CORE_NAMING=yes /usr/HTTPServer/bin/apachectl start
/usr/HTTPServer/bin/apachectl start: httpd started
```

2. Check the process ID of the parent httpd process:

```
# ps -afe | grep httpd
nobody 4042 24046 0 08:41:27 - 0:00 /usr/HTTPServer/bin/httpd
imnadm 15232 1 0 May 16 - 0:00
/usr/IMNSearch/httpd-lite/httpd-lite -r
/etc/IMNSearch/httpd-lite/httpd-lite.conf
root 24046 1 0 08:41:26 - 0:00 /usr/HTTPServer/bin/httpd
nobody 27246 24046 0 08:41:27 - 0:00 /usr/HTTPServer/bin/httpd
nobody 28248 24046 0 08:41:27 - 0:00 /usr/HTTPServer/bin/httpd
root 35570 39628 1 08:41:35 pts/1 0:00 grep httpd
nobody 49230 24046 0 08:41:27 - 0:00 /usr/HTTPServer/bin/httpd
nobody 52756 24046 0 08:41:27 - 0:00 /usr/HTTPServer/bin/httpd
```

3. Send the SIGSEGV signal to the parent httpd process (in this example, PID 24046) to have it dump the core on purpose:

```
# kill -SEGV 24046
```

4. Confirm the core file is produced. The core file name should contain a process ID and a timestamp in GMT:

```
# ls -l /usr/HTTPServer/core*
-rw-r--r-- 1 root system 10151 Jun 19 08:43
/usr/HTTPServer/core.24046.18234327
```

5. Stop the remaining child httpd processes:

```
# kill -KILL 4042 27246 28248 49230 52756
```

6. Wait for a couple of minutes and check to see if httpd has restarted:

```
# ps -afe | grep httpd
nobody 4052 38806 0 08:45:31 - 0:00 /usr/HTTPServer/bin/httpd
nobody 6358 38806 0 08:45:31 - 0:00 /usr/HTTPServer/bin/httpd
```

```

imnadm 15232    1  0  May 16    -  0:00
/usr/IMNSearch/httpd-lite/httpd-lite -r
/etc/IMNSearch/httpd-lite/httpd-lite.conf
nobody 35712 38806  0 08:45:31    -  0:00 /usr/HTTPServer/bin/httpd
root 38806    1  0 08:45:29    -  0:00 /usr/HTTPServer/bin/httpd
nobody 39968 38806  0 08:45:31    -  0:00 /usr/HTTPServer/bin/httpd
nobody 50066 38806  0 08:45:31    -  0:00 /usr/HTTPServer/bin/httpd
root 52770 39628  0 08:45:33 pts/1 0:00 grep httpd

```

7. Check if the core file was moved:

```

# ls -l /home/rmctest/corefiles
total 20
-rw-r--r--  1 root    system      10151 Jun 19 08:43
core.24046.18234327

```

5.3 How to send events to Tivoli Enterprise Console

In this section, we describe how to send responses from RMC to Tivoli Enterprise Console (TEC) so that you can integrate your monitoring system into a single event console managed by TEC. We select DB2 UDB (explained in Section 5.1, “How to monitor DB2 Universal Database” on page 152) as our monitoring application.

Although we introduce some basic examples in this section, you can apply this implementation to other monitoring resources. As you can see in this scenario, TEC can provide a single view of the events detected in the monitoring environment. This implementation will be useful when you have the following environments or situations:

- ▶ Tivoli Enterprise products have been deployed in your environment.
- ▶ TEC console has been used for central event console in your performance and availability management.
- ▶ Critical applications are up and running on AIX and need to be strictly monitored.
- ▶ You want to monitor the critical applications (on AIX) as well as the other monitoring resources that have been monitored by Tivoli Enterprise applications.

This scenario allows you to establish a comprehensive monitoring hierarchy where TEC console will provide the first view. TEC informs you of events detected by RMC, and the *Severity* field will tell you how serious the event is. Then, you may need to look at the event in detail by using RMC, if the event indicates an outstanding issue.

To implement the RMC action script that sends the response from RMC to TEC, we use the TEC command **postemsg** in this section. You can also use the **wpostemsg** command instead of the **postemsg** command. The difference between these two commands is whether it is secure or not. The **wpostemsg** command is secure, so the data sent over the network is encrypted, while the **postemsg** command is insecure. To use **wpostemsg**, a Tivoli endpoint needs to be installed on the monitored AIX system.

Note: The **postemsg** command is provided by TEC. In order to use this command, you have to copy this command from TEC server to the server that will use this command. You have to purchase an additional TEC license on every single node using the **postemsg** command. For detailed license information for TEC, please contact your IBM sales representative or business partner.

For further information about the **postemsg** and **wpostemsg** commands, please refer to the *Tivoli Enterprise Console Reference Manual Version 3.7.1*, GC32-0666.

5.3.1 System environment of TEC

Figure 5-2 on page 172 illustrates the configuration used in our test environment. The TEC server (host name is kumiogu) is installed with the following software components:

- ▶ AIX Version 4.3.3 Maintenance Level 09
- ▶ DB2 Universal Database for AIX Version 7.1 (used for TEC event database)
- ▶ Tivoli Management Framework Version 3.7.1 (prerequisite component of TEC)
- ▶ Tivoli Enterprise Console Version 3.7.1

We are going to configure an AIX 5L Version 5.1 system (host name is tecclient) that sends a message to the TEC server using RMC.

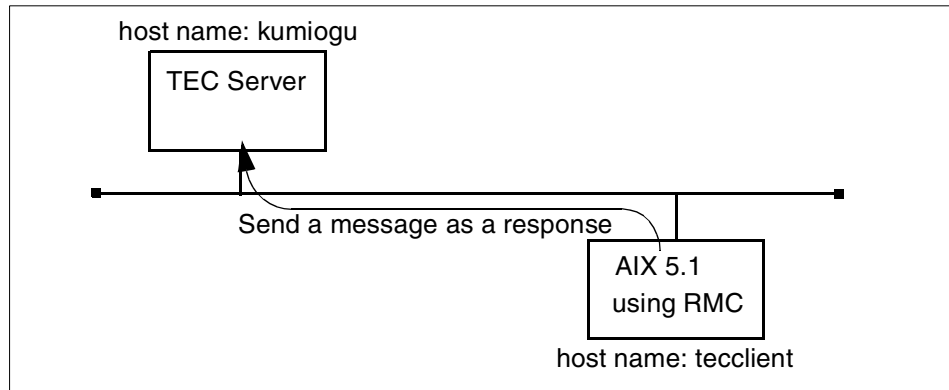

Figure 5-2 Test environment with a TEC server

5.3.2 Create an action script to report to TEC

Example 5-15 is an example action script to send a message to TEC.

Example 5-15 *tecevent* script

```
#!/bin/sh
if [ "$ERRM_EXPR" = "Processes.CurPidCount > 0" ]; then
    state="up"
elif [ "$ERRM_EXPR" = "Processes.CurPidCount <= 0" ]; then
    state="down"
fi
/home/rmctest/postemsg -S kumiogu -m "UDB $state" -r WARNING Logfile_Base LOGFILE \
>> /home/rmctest/log
```

In this example, we have placed the **postemsg** command in the `/home/rmctest`. The specified optional flags of the **postemsg** command are:

- S** Specify the TEC server's host name.
- m** Specify the message body.
- r** Specifies the severity class, which is one of the following: FATAL, CRITICAL, MINOR, WARNING, HARMLESS, and UNKNOWN.

To associate the condition "UDB server state" (described in Example 5-3 on page 155) and the *tecevent* action script, do the following steps:

1. Create the response "Post event to TEC":

```
# mkresponse -n "Post event to TEC" -s /home/rmctest/tecevent \
-e b "Post event to TEC"
```

The `-e b` option instructs the command to invoke the action script upon the occurrence of both the event and the rearm event.

2. Associate the condition “UDB server state” and the response “Post event to TEC”:

```
# mkcondresp 'UDB server state' 'Post event to TEC'
```

3. Start monitoring:

```
# startcondresp 'UDB server state' 'Post event to TEC'
```

Figure 5-3 shows a sample TEC window after we recycled the DB2 UDB instance several times.

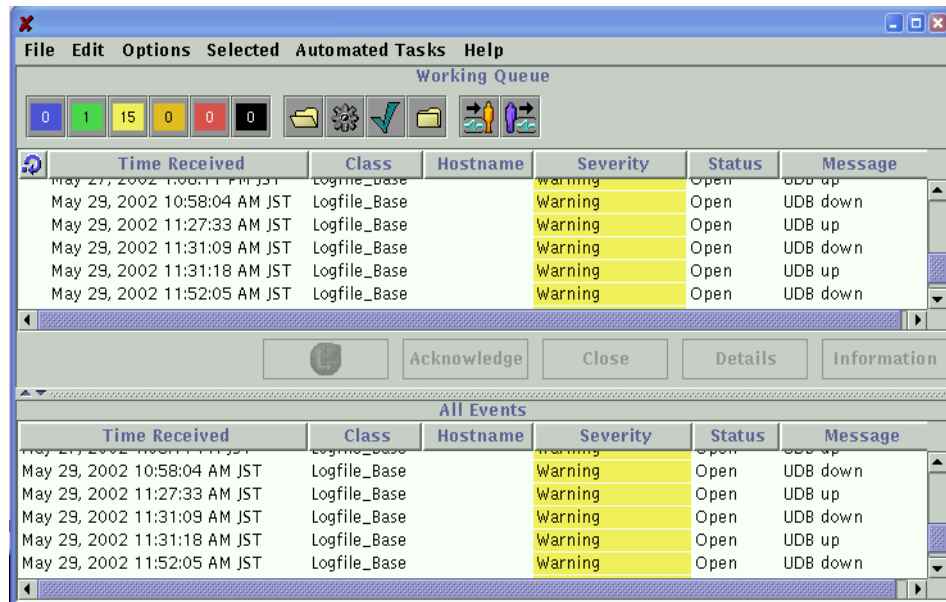

Figure 5-3 TEC console sample in summary chart view²⁵

²⁵ This screen image is captured on a Windows XP based PC, where we installed an X server application. The TEC application is running on the TEC server, and the graphical user interface is displayed on the PC.



A

Filesets level information

This appendix provides detailed level information about the filesets used in our test environment.

At the time of writing of this redbook, the recommended maintenance levels (RMLs) 5100-01 and 5100-02 are available for AIX 5L Version 5.1 and they are installed on our test systems:

```
# instfix -i | grep ML
  All filesets for 5.0.0.0_AIX_ML were found.
  All filesets for 5.1.0.0_AIX_ML were found.
  All filesets for 5.1.0.0_AIX_ML were found.
  All filesets for 5100-01_AIX_ML were found.
  All filesets for 5100-02_AIX_ML were found.
```

Therefore, the `oslevel -r` command returns the following output:

```
# oslevel -r
5100-02
```

This appendix contains the following:

- ▶ “RSCT and RMC filesets level” on page 176
- ▶ “Web-based System Manager filesets level” on page 177

RSCT and RMC filesets level

Example A-1 shows the RSCT and RMC filesets level used in our test environment. The APAR IY30258 is provided to refer to the fileset updates level, rsct.*.2.2.1.10.

Note: You may see additional message filesets installed, such as rsct.msg.EN_US.core.auditrm, depending on the locale settings on your system.

Example: A-1 RSCT and RMC filesets level

```
# lsipp -L "rsct.*"
Fileset                Level  State  Type  Description (Uninstaller)
-----
rsct.basic.hacmp       2.2.1.10  C    F    RSCT Basic Function (HACMP/ES
Support)
rsct.basic.rte         2.2.1.10  C    F    RSCT Basic Function
rsct.basic.sp          2.2.1.10  C    F    RSCT Basic Function (PSSP
Support)
rsct.compat.basic.hacmp 2.2.1.10  C    F    RSCT Event Management Basic
Function (HACMP/ES Support)
rsct.compat.basic.rte  2.2.1.10  C    F    RSCT Event Management Basic
Function
rsct.compat.basic.sp   2.2.1.10  C    F    RSCT Event Management Basic
Function (PSSP Support)
rsct.compat.clients.hacmp 2.2.1.10  C    F    RSCT Event Management Client
Function (HACMP/ES Support)
rsct.compat.clients.rte 2.2.1.10  C    F    RSCT Event Management Client
Function
rsct.compat.clients.sp 2.2.1.10  C    F    RSCT Event Management Client
Function (PSSP Support)
rsct.core.auditrm      2.2.1.10  C    F    RSCT Audit Log Resource Manager
rsct.core.errm         2.2.1.10  C    F    RSCT Event Response Resource
Manager
rsct.core.fsrms        2.2.1.10  C    F    RSCT File System Resource
Manager
rsct.core.gui          2.2.1.10  C    F    RSCT Graphical User Interface
rsct.core.hostrm       2.2.1.10  C    F    RSCT Host Resource Manager
rsct.core.rmc          2.2.1.10  C    F    RSCT Resource Monitoring and
Control
rsct.core.sec          2.2.1.10  C    F    RSCT Security
rsct.core.sensorrm     2.2.1.10  C    F    RSCT Sensor Resource Manager
rsct.core.sr           2.2.1.10  C    F    RSCT Registry
rsct.core.utils        2.2.1.10  C    F    RSCT Utilities
rsct.msg.en_US.core.auditrm
```

	2.2.0.0	C	F	RSCT Audit Log RM Msgs - U.S. English
rsct.msg.en_US.core.errm	2.2.0.0	C	F	RSCT Event Response RM Msgs - U.S. English
rsct.msg.en_US.core.fsrn	2.2.0.0	C	F	RSCT File System RM Msgs - U.S. English
rsct.msg.en_US.core.gui	2.2.0.0	C	F	RSCT GUI Msgs - U.S. English
rsct.msg.en_US.core.hostrm				
	2.2.0.0	C	F	RSCT Host RM Msgs - U.S. English
rsct.msg.en_US.core.rmc	2.2.0.0	C	F	RSCT RMC Msgs - U.S. English
rsct.msg.en_US.core.sec	2.2.0.0	C	F	RSCT Security Msgs - U.S. English
rsct.msg.en_US.core.sensorrm				
	2.2.0.0	C	F	RSCT Sensor RM Msgs - U.S. English
rsct.msg.en_US.core.sr	2.2.0.0	C	F	RSCT Registry Msgs - U.S. English
rsct.msg.en_US.core.utils	2.2.0.0	C	F	RSCT Utilities Msgs - U.S. English

State codes:

- A -- Applied.
- B -- Broken.
- C -- Committed.
- O -- Obsolete. (partially migrated to newer version)
- ? -- Inconsistent State...Run lppchk -v.

Type codes:

- F -- Installp Fileset
- P -- Product
- C -- Component
- T -- Feature
- R -- RPM Package

Web-based System Manager filesets level

Example A-2 shows the Web-based System Manager filesets level used in our test environment.

Example: A-2 Web-based System Manager filesets level

```
# lsipp -L 'sysmgt.websm.*'
```

Fileset	Level	State	Type	Description (Uninstaller)
sysmgt.websm.apps	5.1.0.25	C	F	Web-based System Manager Applications

sysmgt.websm.diag	5.1.0.25	C	F	Web-based System Manager Diagnostic Applications
sysmgt.websm.framework	5.1.0.25	C	F	Web-based System Manager Client/Server Support
sysmgt.websm.icons	5.1.0.25	C	F	Web-based System Manager Icons
sysmgt.websm.rte	5.1.0.25	C	F	Web-based System Manager Runtime Environment
sysmgt.websm.webaccess	5.1.0.25	C	F	WebSM Web Access Enablement

State codes:

- A -- Applied.
- B -- Broken.
- C -- Committed.
- O -- Obsolete. (partially migrated to newer version)
- ? -- Inconsistent State...Run lppchk -v.

Type codes:

- F -- Installp Fileset
 - P -- Product
 - C -- Component
 - T -- Feature
 - R -- RPM Package
-



B

Useful information

This appendix contains useful information about Resource Monitoring and Control, including:

- ▶ “rsct.core.README” on page 180
- ▶ “Perl/Expect installation” on page 184

rsct.core.README

This section includes an excerpt of the rsct.core.README file provided with AIX 5L Version 5.1.

Note: We slightly changed the contents from the original README file on purpose, mainly to improve the readability. We also deliberately did not include legal information in here for the limited space of this redbook. Please print the README file on your system to confirm the latest information.

Description

This is the README for RSCT Resource Monitoring and Control, Version 2 Release 2. It contains the latest information about this release, including installation pointers, documentation updates, and restrictions. The information in this README supersedes any of the previously documented instructions for this release.

This README pertains to all the filesets included with RSCT Resource Monitoring and Control 2.2. They are:

- ▶ rsct.core.auditrm
- ▶ rsct.core.errm
- ▶ rsct.core.fsrn
- ▶ rsct.core.gui
- ▶ rsct.core.hostrn
- ▶ rsct.core.rmc
- ▶ rsct.core.sec
- ▶ rsct.core.sensorrm
- ▶ rsct.core.sr
- ▶ rsct.core.utils

Installation information

The Reliable Scalable Cluster Technology (RSCT) requires the installation of several filesets, including the bos.perf.perfstat, bos.rte, bos.rte.iconv, bos.iconv.com, bos.iconv.ucsv.com, perl.rte, and bos.net.tcp.client filesets. These requirements are enforced by having a co-requisite of bos.perf.perfstat and a prerequisite of the others. These filesets are shipped with AIX 5L Version 5.1.

There is a special procedure when RSCT is installed from a System Image or NIM. Since RSCT stores node specific configuration information in the `/etc` and `/var/ct/cfg` directories, creating a system (mksysb) image from a node and restoring it to another node may cause unexpected behavior from the RMC subsystem. Therefore, one of the following methods should be used for installation or upgrading using a system image:

1. Build a system image, including a `/etc/firstboot` script.

Before creating a system image, `/etc/firstboot` must be edited to include `/usr/sbin/rsct/install/bin/recfgct`. The `/etc/firstboot` script will be executed during the first boot after the installation. A system image created using this method may not be used for an upgrade.

2. Use NIM resource type (script).

The NIM installation procedure provides a method to execute some actions after the installation. Include `/usr/sbin/rsct/install/bin/recfgct` in this script.

3. On PSSP, use `firstboot.cust` script.

There is a sample script, `/usr/lpp/ssp/samples/firstboot.cust`, which is designed to be used by the user as a guide for some functions that might be performed after a node has been network installed, and after it boots for the first time. Add `/usr/sbin/rsct/install/bin/recfgct` to the `/tftpboot/firstboot.cust` script.

4. Manually reset the node specific configuration information.

After the installation, invoke the `/usr/sbin/rsct/install/bin/recfgct` command, which will regenerate the node specific configuration information.

Advisories

The following advisories should be noted.

Backing up the `/var/ct` directory

The `/var/ct` directory and all its subdirectories should be backed up periodically. These directories are used by the RMC subsystems to store resource persistent data and other configuration information.

In addition, if major configuration changes are made via CSM commands or the Web-based System Manager Monitoring application, a backup of this directory should be performed.

Perform the following steps to do a backup:

1. Execute the following command to stop the RMC subsystems. The command does not complete until all RMC subsystems are stopped:

```
# /usr/sbin/rsct/bin/rmcctrl -z
```

2. Perform a backup of the `/var/ct` directory.
3. Execute the following command to restart the RMC subsystems:

```
# /usr/sbin/rsct/bin/rmcctrl -s
```

To restore the `/var/ct/` directory, perform the following steps:

1. Execute the following command to stop the RMC subsystems:

```
# /usr/sbin/rsct/bin/rmcctrl -z
```

2. Restore the `/var/ct` directory.
3. Execute the following command to restart the RMC subsystems:

```
# /usr/sbin/rsct/bin/rmcctrl -s
```

Modifying a Cluster Security configuration file

The Cluster Security (CtSec) component of RSCT provides a sub-service that performs authentication functions based on host identities. This sub-service, called *ctcas*, comes with a text formatted configuration file shipped in `/usr/sbin/rsct/cfg/ctcasd.cfg`. Within this file are definitions of the maximum number of threads the daemon may create, the minimum number of threads to keep running when the daemon is idle, the path names of the default host private and public keyfiles, and what default host identifier key generation method is to be used by the *ctcas* service. If a system administrator wishes to modify any of these values, the `/usr/sbin/rsct/cfg/ctcasd.cfg` file must be copied to the file `/var/ct/cfg/ctcasd.cfg`, and any desired modification must be made to the `/var/ct/cfg/ctcasd.cfg` version. The default file, `/usr/sbin/rsct/cfg/ctcasd.cfg`, must not be modified. When the *ctcas* sub-service is started, it will search first for the `/var/ct/cfg/ctcasd.cfg` file, and then for the `/usr/sbin/rsct/cfg/ctcasd.cfg` file, if the former is not found.

Memory requirement for Web-based System Manager

The minimum memory requirement to run a Web-based System Manager session is 256 MB. However, if you plan to run the Monitoring application from more than one Web-based System Manger session at the same time on a system, more than 256 MB of memory is recommended to enhance performance.

Predefined responses

When the responses specified with the predefined `notifyevent`, `wallevent`, or `logevent` scripts are used in a Japanese locale, English should be used for all input fields in the monitoring plug-in and for all options on the command line. This restriction is necessary since the commands invoked in these sample scripts do not handle Japanese characters correctly in all cases. If you modify these scripts

or create new ones to handle double-byte characters correctly, then this restriction does not apply.

Three new Event Response scripts, `ewallevent`, `enotifyevent`, and `elogevent`, are provided in the directory `/usr/sbin/rsct/bin`. These scripts provide the same function as the predefined scripts `wallevent`, `notifyevent`, and `logevent`. The predefined scripts report events in the language of the system's default locale. In contrast, the three new scripts always report events in English. User specified text, such as condition names or response names, is reported as specified by the user; such text might not be in English.

You can use the new scripts while defining responses from the Monitoring plug-in of a Web-based System Manager session or using the ERRM CLI:

- ▶ From the Monitoring plug-in, bring up a new Response property dialog and add a new action by selecting the “Run program” option from the Action dialog box. Provide the absolute path name of a new script, for example, `/usr/sbin/rsct/bin/elogevent`. If an event occurs for a condition that uses the response, the response will take place, and the program specified in the response will run; in other words, the `elogevent` script will be invoked, and the event will be logged into the file in English.
- ▶ Similarly, from the CLI, specify the new script's absolute path name with the `-s` option when you add a new action to a response using the ERRM commands `mkresponse` or `chresponse`.

Display limitations for Web-based System Manager

- ▶ Environment variables set for a response via the command line will not be displayed in the Web-based System Manager.
- ▶ The `ManagementScope` persistent attribute of the `IBM.Condition` class is not displayed in the Condition property dialog box of the Web-based System Manager.
- ▶ The Web-based System Manager will only display conditions whose `ManagementScope` persistent attribute has a value of 1 (meaning local scope).
- ▶ Users are not able to create a response with no actions using the Web-based System Manager. However, such responses created via the command line will be available for monitoring via the Web-based System Manager.

World Wide Web access information

The RSCT documentation is available as Portable Document Format (PDF) files from the IBM Publications Web site:

<http://www.ibm.com/shop/publications/order>

The RSCT books are also available from the URL:

<http://www.ibm.com/servers/eserver/clusters/library>

You can view or download the following books:

- ▶ *IBM RSCT: Group Services Programming Guide and Reference*, SA22-7888
- ▶ *IBM RSCT for AIX: Guide and Reference*, SA22-7889
- ▶ *IBM RSCT for AIX: Technical Reference*, SA22-7890
- ▶ *IBM RSCT for AIX: Messages*, GA22-7891

To view the RSCT PDF publications, you need access to the Adobe Acrobat Reader. The Acrobat Reader is freely available from the Adobe Web site at:

<http://www.adobe.com>

To successfully print a large PDF file (approximately 300 or more pages) from the Adobe Acrobat reader, you may need to select the “Download Fonts Once” button on the Print window.

Perl/Expect installation

To install Perl/Expect and related modules, visit the Comprehensive Perl Archive Network (CPAN) site that archives all the modules for Perl. You can access CPAN at the following URL:

<http://www.cpan.org>

The following steps explain how to install Perl/Expect on AIX 5L Version 5.1:

1. Download the following three modules²⁶ from CPAN:
 - Expect-1.15.tar.gz
 - IO-Stty-IO-Stty-.02.tar.gz
 - IO-Tty-1.02.tar.gz
2. Install IBM C compiler Version 5 and the GNU gzip²⁷ command.
3. Make sure you have a minimum of 1 MB free space in /usr.
4. Install these modules, as shown in the following example:

```
$ cd /work/src/Expect_modules
$ gzip -d -c ../source_package/IO-Tty-1.02.tar.gz | tar -xf -
$ cd IO-Tty-1.02
$ perl Makefile.PL
```

²⁶ You might see newer version of these modules on CPAN.

²⁷ The GNU gzip command is provided by AIX toolbox for Linux applications.

```

$ make
$ su -
# cd /work/src/Expect_modules/I0-Tty-1.02
# make install
# exit
$
$ cd /work/src/Expect_modules
$ gzip -d -c ../source_package/I0-Stty-.02.tar.gz | tar -xf -
$ cd I0-Stty-.02
$ perl Makefile.PL
$ make
$ su -
# cd /work/src/Expect_modules/I0-Stty-.02
# make install
# exit
$
$ cd /work/src/Expect_modules
$ gzip -d -c ../source_package/Expect-1.15.tar.gz|tar -xf -
$ cd Expect-1.15
$ perl Makefile.PL
$ make
$ su -
# cd /work/src/Expect_modules/Expect-1.15
# make install
# exit

```

5. You will see the following files installed under the `/usr/opt/perl5/lib/site_perl/5.6.028` directory:

```

# ls -lR | grep -v CT
total 208
-r--r--r-- 1 root system 52845 Mar 19 05:59 Expect.pm
-r--r--r-- 1 root system 41666 Mar 19 05:59 Expect.pod
drwxr-xr-x 2 root system 512 May 10 14:46 I0
drwxr-xr-x 4 root system 512 May 10 14:43 aix
./I0:
total 40
-r--r--r-- 1 root system 14416 Jan 05 1998 Stty.pm
-r-xr-xr-x 1 root system 198 Dec 05 1997 stty.pl

./aix:
total 16
drwxr-xr-x 3 root system 512 May 10 14:43 I0
drwxr-xr-x 4 bin bin 512 May 10 14:47 auto

./aix/I0:
total 48
-r--r--r-- 1 root system 8517 Apr 02 06:29 Pty.pm

```

²⁸ The Perl version provided by AIX 5L Version 5.1 is 5.6.0.

```

drwxr-xr-x  2 root    system      512 May 10 14:43 Tty
-r--r--r--  1 root    system      7277 Apr 02 06:29 Tty.pm

./aix/I0/Tty:
total 16
-r--r--r--  1 root    system      7184 May 10 14:37 Constant.pm

./aix/auto:
total 24
drwxr-xr-x  2 root    system      512 May 10 14:47 Expect
drwxr-xr-x  4 root    system      512 May 10 14:46 I0

./aix/auto/Expect:
total 8
-rw-r--r--  1 root    system      120 May 10 14:47 .packlist

./aix/auto/I0:
total 16
drwxr-xr-x  2 root    system      512 May 10 14:46 Stty
drwxr-xr-x  2 root    system      512 May 10 14:43 Tty

./aix/auto/I0/Stty:
total 8
-rw-r--r--  1 root    system      92 May 10 14:46 .packlist

./aix/auto/I0/Tty:
total 80
-rw-r--r--  1 root    system      372 May 10 14:43 .packlist
-r--r--r--  1 root    system        0 May 10 14:38 Tty.bs
-r-xr-xr-x  1 root    system     34222 May 10 14:38 Tty.so

```

Abbreviations and acronyms

ACL	Access Control List	TS	Topology Service
API	Application Program Interface		
CDE	Common Desktop Environment		
CPAN	Comprehensive Perl Archive Network		
CSM	IBM Cluster Systems Management		
CtSec	Cluster Security		
DB2 UDB	DB2 Universal Database for AIX		
DMSRM	Domain Resource Manager		
ERRM	Event Response Resource Manager		
GS	Group Service		
HA	High Availability		
HAEM	High Availability Event Monitoring		
IBM	International Business Machines Corporation		
IHS	IBM HTTP Server		
ITSO	International Technical Support Organization		
IW	Independent Workstation		
PDF	Portable Document Format		
PSSP	Parallel System Support Program		
RMC	Resource Monitoring Control		
RSCT	Reliable Scalable Cluster Technology		
SD	Structured Data		
SP	Scalable Parallel		
SRC	System Resource Controller		
TEC	Tivoli Enterprise Console		

Related publications

The publications listed in this section are considered particularly suitable for a more detailed discussion of the topics covered in this redbook.

IBM Redbooks

For information on ordering these publications, see “How to get IBM Redbooks” on page 190.

- ▶ *GPFS on AIX Clusters: High Performance File System Administration Simplified*, SG24-6035
- ▶ *Linux Clustering with CSM and GPFS*, SG24-6601
- ▶ *Managing AIX Server Farms*, SG24-6606
- ▶ *PSSP Version 3 Survival Guide*, SG24-5344
- ▶ *RS/6000 SP Cluster: The Path to Universal Clustering*, SG24-5374
- ▶ *RSCT Group Services: Programming Cluster Applications*, SG24-5523

Other resources

These publications are also relevant as further information sources:

- ▶ *AIX 5L Version 5.1 Installation Guides: Installation Guide**
- ▶ *AIX 5L Version 5.1 Installation Guides: Network Installation Management Guide and Reference**
- ▶ *AIX 5L Version 5.1 Reference Documentation: Commands Reference**
- ▶ *AIX 5L Version 5.1 System Management Guides: AIX 5L Version 5.1 Web-based System Manager Administration Guide**
- ▶ *AIX 5L Version 5.1 System Management Guides: Operating System and Devices**
- ▶ *IBM RSCT: Group Services Programming Guide and Reference*, SA22-7888
- ▶ *IBM RSCT for AIX: Guide and Reference*, SA22-7889
- ▶ *IBM RSCT for AIX: Messages*, SA22-7891
- ▶ *IBM RSCT for AIX: Technical Reference*, SA22-7890

You can access all of the pSeries hardware related documentation through the Internet at the following URL:

http://www.ibm.com/servers/eserver/pseries/library/hardware_docs/index.html

You can also access all of the AIX documentation through the Internet at the following URL:

<http://www.ibm.com/servers/aix/library>

The publications marked with * in the list are located on the documentation CD-ROM that ships with the AIX operating system:

Referenced Web sites

These Web sites are also relevant as further information sources:

- ▶ Adobe Systems
<http://www.adobe.com>
- ▶ AIX 5L Version 5.1 Web-based System Manager
<http://www-1.ibm.com/servers/aix/os/wsm/51/>
- ▶ Comprehensive Perl Archive Network
<http://www.cpan.org>
- ▶ IBM @server Cluster
<http://www-1.ibm.com/servers/eserver/clusters/>
- ▶ IBM @server pSeries Resource Library
<http://www-1.ibm.com/servers/eserver/pseries/library>
- ▶ IBM Publications Center
<http://www.ibm.com/shop/publications/order>

How to get IBM Redbooks

You can order hardcopy Redbooks, as well as view, download, or search for Redbooks at the following Web site:

ibm.com/redbooks

You can also download additional materials (code samples or diskette/CD-ROM images) from that site.

IBM Redbooks collections

Redbooks are also available on CD-ROMs. Click the CD-ROMs button on the Redbooks Web site for information about all the CD-ROMs offered, as well as updates and formats.

Index

Symbols

!~ 103
103
\$PATH 35
% 103
/dev/hd6 115
/etc/firstboot 181
/etc/inittab 114
/home/remount 83
/home/rmctest/program.sh 157
/SharedTools 94
/tmp/inform.log 91
/usr/bin 35
/usr/lpp/ssp/samples/firstboot.cust 181
/usr/sbin/rsct 35
/usr/sbin/rsct/bin 35
/usr/sbin/rsct/cfg/ctrmc.acls 143
/usr/sbin/rsct/install/bin/recfgct 181
/var/ct 35
/var/ct/ 36
/var/ct/cfg/ct_has.thl 149
/var/ct/cfg/ctrmc.acls 144
=? 103
=~ 103
@P 136
^ 105
_ 103
~? 103

A

Access Control List 143
ACL 143
action 32
ActionScript field 133
Add Action 84
Adding a node to the cluster 109
additional time-out logic 161
addrpnode 109
aggregate data type 22
AIX errorlog 26
AIX kernel 168
AIX security audit function 26
AIX toolbox for Linux applications 184

AIX user-id 124
All day 70
All day Everyday 85
All Events 56
alog command 26
APAR IY30258 176
architecture 16
array 22
association 34
ATM 29
Attempt remount 82
attribute 21
Audit Log commands 142
Audit Log resource manager 26
authentication 143
authorization 143
automatic 101

B

Backing up the /var/ct Directory 181
base data type 21
big-file-enabled 120
Bringing a node online 110
Bringing the cluster online 108
Broadcast message 67

C

caret character 105
CDE 39
chcondition 139
CheckReturnCode 134
chresponse 141
chrsrc 115
chsensor 125
CLI 17
Client-Server mode 38
Cluster Security 182
Cluster Technology 16
cluster_id 36
clustered environment 5
CMD 153
command line history 19
Command line interface 17

- Common Desktop Environment 39
- commonly used command flags 99
- Comprehensive Perl Archive Network 184
- condition 30
- Condition Properties dialog 59
- Condition property dialog 45
- Conditions plug-in 48
- condresp 126
- ConfigChanged 62
- core file 167
- CORE_NAMING 168
- CPAN 184
- Create your own response 167
- Creating the cluster 107
- CSM 7
- CSM agent resource manager 6
- CSM Agent RM 6
- CT 16
- CT_CONTACT 95
- ct_has.pkf 148
- ct_has.qkf 148
- CT_MANAGEMENT_SCOPE 95
- ctcas 182
- CtSec 182
- ctskeygen 148
- ctsthl 149
- Current Events 56

D

- Day of Week 68, 85
- DB2 Universal Database 151
- db2admin 155
- db2alert.log 152
- db2diag.log 152
- db2gds 153–154
- db2ipccm 153
- db2resyn 153
- db2srvtst 154
- db2sysc 153–154
- db2tccm 153
- db2wdog 153
- DEFAULT 147
- Define your own sensor 156
- description of a resource class 119
- Display Limitations for Web-based System Manager 183
- DMSRM 6
- DNS 94

- DNS domain 94
- do loop 122
- domain resource manager 6
- dot 103
- double-quote characters 121
- dynamic attribute 23

E

- echo command 117
- Edit Responses to Start Monitoring 50
- elogevent 33
- e-mail 159
- e-mail address 167
- enotifyevent 33
- ERRM 24
- ERRM_ 138
- ERRM_RSRC_NAME 33
- ERRM_VALUE 167
- Ethernet 29
- event database 171
- event expression 76
- Event Monitoring 4
- Event Properties dialog 56
- Event Response resource manager 24
- event sensor command 157
- EventType 134
- ewallevent 33
- exchange public keys 107
- Expect language 162
- Expect.pm 162
- Expect/Perl 162
- expecting string pattern 164
- expression 30
- extended regular expression operators 103

F

- false 101
- FDDI 29
- File System resource manager 28
- fileset 8
- firewall 12
- FQDN 94
- full path name 122
- fully qualified domain name 94

G

- generic RMC commands 114

geographical aspects 95
Global daemon spawner 153
GMT 168
GNU gzip 184
Graphical user interface 17
Greenwich mean time 168
Group Service 4
GS 4
GUI 17

H

HA 4
HAEM 4
High Availability 4
host resource manager 28
hostname command 94
HTTP request 164
httpcheck 157
httpd 167
httpd server state 158
httpdrestart 169

I

IBM C compiler Version 5 184
IBM Cluster Systems Management 7
IBM HTTP Server 151
IBM.ATMDevice 29
IBM.EthernetDevice 29
IBM.FDDIDevice 29
IBM.Host 28
IBM.HostPublic 28
IBM.PagingDevice 28
IBM.PhysicalVolume 28
IBM.Processor 28
IBM.Program 29
IBM.Sensor resource class 156
IBM.TokenRingDevice 29
IHS 151
Independent Workstation 35
instfix 175
Int32 158
IO

Socket package 164
itsc.austin.ibm.com 94
IW 35

J

Japanese characters 182
JFS 120

L

large file enabled feature 120
Linux operating system 7
listener process 153
locale 113
location concepts 127
Log File 67
Log On dialog 41
logevent 32
logevent action 26
logical volume 115
lsactdef 106, 115
lsaudrec 142
lscondition 117, 127
lscondresp 134
lsresponse 132
lsrpdomain 108
lsrsrc 115
lsrsrc command 96
lsrsrcdef 106, 119
lssensor 123
lssrc 112

M

management domain 5
Management Environment tree 43
management server 7
MaxSize attribute 142
Memory Requirement for Web-based System Manager 182
message body 167
message catalog 9
mgr_name entry 120
MgtScope 131
mkcondition 117, 135
mkcondresp 139
mkresponse 137, 156
mkrpdomain 107
mkrsrc 115
mksensor 125
mksysb 181
Modifying a Cluster Security Configuration File 182
monitored property 47
Monitoring plug-in 48

MonitorStatus attribute 131
MountDir 102
MountPoint 102

N

Navigation Area 41
new condition 71
new response 80
NIM 181
NIM resource type 181
nlssrc 113
node 27
Node attribute 131
NodeNames attributes 131
not valid for define 116
notifyevent 32
NumUsers 123, 136

O

OpState 62
optional for define 116
oslevel 175

P

paging space 115
Parallel System Support Program 4
PATH 137
Pattern match operators 102
pattern matching 102
PC applet mode 38
PC client 40
PC client mode 38
PctTotalTimeldle 136
peer domain 5
percent sign 103
PercentlNodeUsed 62
PercentTotUsed 62, 102
Perl 162
Perl module 162
persistent attribute 22
postemsg 171
pound sign 103
predefined actions 32
Predefined Responses 182
Preparing your node security 107
preprnode 107
ps 152

pSeries xiii
PSSP 4
public 116
public-key based security mechanism 107

Q

query request 160
quorum 27

R

read only 116
rearm expression 76
recommended maintenance level 175
Redbooks Web site 190
 Contact us xv
refresh 113
refresh command 121
RefreshInterval 157
regular expression 102
Reinstall RMC 12
Reliable Scalable Cluster Technology 4
Remote node access 147
Removing a cluster 112
Removing a node 111
required for define 116
resource 20
resource class 21
resource manager 23
Resource Monitoring and Control 1
Resource Monitoring and Control application user
interface 17
Resource_Data_Input 106
ResourceHandle 117
response 33
Resync agent process 153
ReturnCode 134
rmaudrec 142
RMC 1
RMC API 17
RMC audit log 26
RMC client 18
RMC subsystem 3
rmcctrl 113
rmcondition 141
rmcondresp 141
RML 175
rmresponse 141
rmrpdomain 112

rmrpnode 111
rmrsrc 115
rmsensor 125
root privilege 146
RS/6000 Scalable Parallel 4
RSCT 4
rsct grou 113
RSCT RMC 3
rsct.core.auditrm 180
rsct.core.errm 180
rsct.core.fsrm 180
rsct.core.gui 180
rsct.core.hostrm 180
rsct.core.README 180
rsct.core.rmc 180
rsct.core.sec 180
rsct.core.sensorm 180
rsct.core.sr 180
rsct.core.utils 180
rsct_rm group 113
rsync 94
Run Program 67

S

SD 22
sed 121
selectable 116
selection string 100
Send mail 67
sensor resource manager 29, 157
Severity field 170
severity level 77
SIGSEGV 169
SMIT 19
smitty 132
snap 89
Software Update Protocol 94
SP 4
SQL-like syntax operators 103
SRC 112
stand-alone 5
Stand-alone application mode 38
StandardOut 134
star 103
startcondresp 139
starttrnode 110
startsrc 113
status bar 44

stopcondresp 141
Stopping (offline) a cluster 111
Stopping (offline) a node 110
stoprpdomain 111
stopsrc 113
String 158
structured data 22
substring match 129
SUP 94
syscat.tables 160
syslog 26
system bundle 9
system controller process 153
System Image 181
system resource controller 112

T

target URL 164
TCP port 12
TCP/IP socket. 164
TEC 170
temporary file 132
test environment 94
tiled display 44
Time of Day 68, 85
time zone 168
timeout value 162
timeout.pl 162
title bar 44
Tivoli endpoint 171
Tivoli Enterprise Console 170
Tivoli Enterprise products 170
Token-Ring 29
Topas 135
topas 131
Topology Service 4
touch 149
true 101
TS 4

U

UDB 151
udbcheck.sh 162
umount /work04. 91
underscore 103
Uninstall RMC 12
UNIX identity-based credentials 113
user defined environment variables 138

Username attribute 124

V

vmstat 131

W

wall command 33

wallevent 32

wallevent command 67

Watchdog process 153

Web-based System Manager 19, 37

When in Effect 68

wild cards 103

wpostmsg 171

wsm& 38

X

X Window system 38

Y

yes command 53



Redbooks

A Practical Guide for Resource Monitoring and Control (RMC)

Configure RMC using the Web-based System Manager

Comprehensive examples of the RMC command line interface

Practical examples on how to monitor your applications

This redbook discusses the capabilities of Resource Monitoring and Control (RMC) that enables you to monitor various resources of your system and create automated responses to changing conditions of those resources. RMC is provided by the AIX 5L Version 5.1 and later operating systems and is a subset of the functionality available in Reliable Scalable Cluster Technology (RSCT). RSCT provides a set of software components that together support a powerful and flexible environment for clustering systems. The focus of this redbook is to explain the architecture and components of RMC and its usage by providing with practical examples in several different configurations, including:

- Introduction
- Architecture and components
- Quick start: using RMC
- RMC command line interface
- Monitoring applications

This redbook is an ideal desk side reference for IBM employees, Business Partners, and customer system administrators or technical specialists who exploit RMC to manage IBM @server pSeries servers running AIX 5L Version 5.1.

**INTERNATIONAL
TECHNICAL
SUPPORT
ORGANIZATION**

**BUILDING TECHNICAL
INFORMATION BASED ON
PRACTICAL EXPERIENCE**

IBM Redbooks are developed by the IBM International Technical Support Organization. Experts from IBM, Customers and Partners from around the world create timely technical information based on realistic scenarios. Specific recommendations are provided to help you implement IT solutions more effectively in your environment.

**For more information:
ibm.com/redbooks**